

Atelier Night System

ADÖK

**ADOK** arreda la tua casa

Atelier Night System

## Atelier Night System

### Armadi con anta battente, scorrevole e pieghevole

Differenti modalità di apertura, una tradizione rivisitata.

Un sapiente e ricercato utilizzo della tecnologia, associato all'impiego di materiali di qualità attentamente selezionati.

La collezione armadi Adok, la modernità di un progetto che garantisce la massima libertà di scelta: nelle finiture, nei materiali, nell'organizzazione degli spazi interni e nelle attrezzature.

Ognuno avrà la possibilità di progettare per la propria casa l'armadio che interpreta al meglio la sua particolare visione dell'arredo.

### Wardrobes with hinged, sliding and folding doors

Different opening methods, a revisited tradition.

A wise and sophisticated use of technology, associated with the use of carefully selected quality materials. The Adok wardrobe collection, the modernity of a project that guarantees maximum freedom of choice: in the finishes, in the materials, in the organization of the internal spaces and in the equipment. Everyone will have the opportunity to design the wardrobe for their home that best interprets their particular vision of furniture.

### Cabine armadio

La cabina armadio è una tipologia d'arredo che si sta sempre più diffondendo. Rappresenta la soddisfazione di un nostro desiderio: entrare in uno spazio di cui solo noi possediamo le chiavi.

È il mondo delle nostre cose, delle scarpe, dell'abbigliamento, di tutto ciò che ci serve per presentarci in pubblico con una certa immagine. Nella sua collezione armadi, Adok la propone in una ricca gamma di soluzioni e finiture, perfettamente integrate nella zona notte mediante un rapporto di continuità.

### Walk-in Wardrobes

The walk-in wardrobe is a type of furniture that is increasingly spreading. It represents the satisfaction of our desire: to enter a space of which only we have the keys.

It is the world of our things, of shoes, of clothing, of everything we need to present ourselves in public with a certain image. In its wardrobe collection, Adok offers it in a rich range of solutions and finishes, perfectly integrated into the sleeping area through a relationship of continuity.

**Armadi con anta battente**

Una tipologia di apertura che rappresenta la tradizione per un elemento d'arredo destinato alla zona notte: il fascino semplice dell'anta battente per un ambiente capace di raccogliere sogni e desideri.

La solida concretezza di una soluzione che garantisce una grande libertà nella concezione delle attrezzature interne. Una scelta "senza maniglia" che privilegia la continuità di una superficie priva di elementi di interruzione, creando una vera e propria architettura domestica.

**Hinged wardrobes**

A type of opening that represents tradition for a piece of furniture intended for the sleeping area: the simple charm of the hinged door for an environment capable of gathering dreams and desires. The solid concreteness of a solution that guarantees great freedom in the design of internal equipment. A "handleless" choice that favors the continuity of a surface without any interruption elements, creating a real domestic architecture.

# Anta battente Hinged door

01 &gt;

**ANTA CRYSTAL**  
**ANTA LOW**

Una soluzione leggera e trasparente, che interpreta l'arredo nella direzione della sottrazione di peso visivo. L'anta Crystal è indubbiamente caratterizzata da una spiccata identità estetica: con la sua originalità nella scelta dei materiali, è capace di regalare all'ambiente notte un fascino intenso e sofisticato. L'abbinamento con l'anta Low valorizza la dimensione funzionale dell'ambiente.

A light and transparent solution, which interprets the furniture in the direction of the subtraction of visual weight. The Crystal door is undoubtedly characterized by a marked aesthetic identity: with its originality in the choice of materials, it is capable of giving the bedroom an intense and sophisticated charm. The combination with the Low door enhances the functional dimension of the room.







Armadi con ante battenti Crystal in vetro Bronzo e telaio in alluminio in finitura Ghisa Metal. Armadio in nicchia con ante battenti Low in legno laccato finitura Canapa e maniglie in finitura Ghisa Metal. L'interno, in finitura Rovere Caramel, è attrezzabile con accessori per l'organizzazione interna, ripiani, cassettiere e tubi appendiabito. A centro stanza penisola per cabine Domino con cassetti Row.

Wardrobes with Crystal hinged doors in Bronzo glass and aluminum frame in Ghisa Metal finish. Niche wardrobe with Low hinged doors in Canapa finish lacquered wood and handles in Ghisa Metal finish. The interior, in Rovere Caramel finish, can be equipped with accessories for internal organisation, shelves, chests of drawers and clothes hanging rails. In the center of the room peninsula for Domino walk-in wardrobes with Row drawers.





**Variante senza ante**

Armadio senza ante per allestimento cabina caratterizzato da telaio in alluminio finitura Ghisa Metal. Mensole, schiene e attrezzature sono in finitura Canvas. Le componenti metalliche, come tubi appendiabiti, telaio portapantaloni e maniglie, sono in finitura Ghisa Metal.

**Variant without doors**

Wardrobe without doors for walk-in wardrobes characterized by an aluminum frame with a Ghisa Metal finish. Shelves, backs and equipments are in Canvas finish. The metal components, such as clothes hanging rails, trouser rack and handles, are in Ghisa Metal finish.

ANTA RULER  
ANTA CRYSTAL

Al centro, due ante battenti Crystal; ai lati, due ante Ruler in posizione equilibrata e simmetrica. Una composizione che unisce l'affascinante intensità del "tutto in vista" di Crystal alla rassicurante razionalità di Ruler, un matrimonio perfettamente riuscito sul piano formale.

In the middle, two Crystal hinged doors; on the sides, two Ruler doors in a balanced and symmetrical position. A composition that combines the fascinating intensity of the "everything in sight" of Crystal with the reassuring rationality of Ruler. A perfectly successful marriage on a formal level.









Armadio componibile con ante in vetro e legno allineate. Ante Ruler in legno laccato finitura Titanio, fianchi in finitura Canvas e maniglie finitura Ghisa Metal. Ante Crystal in vetro Fumé e telaio in alluminio finitura Ghisa Metal. L'interno dell'armadio, in finitura Canvas, è attrezzabile con accessori per l'organizzazione.

Modular wardrobe with aligned glass and wood doors. Ruler doors in lacquered wood with Titanium finish, sides in Canvas finish and handles in Ghisa Metal finish. Crystal doors in Fumé glass and aluminum frame with Ghisa Metal finish. The interior of the wardrobe, in Canvas finish, can be equipped with accessories for organization.



Ante Ruler in legno laccato finitura Titanio, fianchi in finitura Canvas e maniglie finitura Ghisa Metal.

Ruler doors in lacquered wood with Titanium finish, sides in Canvas finish and handles in Ghisa Metal finish.



ANTA LINE + MANIGLIA SLOT  
ANTA CRYSTAL

Una soluzione che gioca sulla presenza combinata di ante differenti per materiali impiegati e, di conseguenza, per la diversità degli effetti visivi che si vengono a creare. Un'immagine che la particolarità della maniglia Slot, un segno estetico caratterizzato da una grande essenzialità, rende originale.

A solution that plays on the combined presence of doors that differ in the materials used and, consequently, in the diversity of the visual effects that are created. An image that the peculiarity of the Slot handle, an aesthetic sign characterized by a great essentiality, makes original.





Armadio con ante Crystal in vetro trasparente, telaio in alluminio finitura Ghisa Metal e fianco in legno laccato Argilla. Armadio con ante Line in legno laccato in finitura Argilla. L'interno, in finitura Canvas, è attrezzato con cassettiere e ripiani inclinati portascarpe.

Wardrobe with Crystal doors in transparent glass, aluminum frame with Ghisa Metal finish and side in Argilla lacquered wood. Wardrobe with Line doors in lacquered wood in Argilla finish. The interior, in Canvas finish, is equipped with drawer units and inclined shoe shelves.





## ANTA SOFT

La preziosità di una collezione che risiede anche nella particolare scelta dei materiali utilizzati. L'anta Soft è una efficace sintesi estetica: abbina il segno forte degli elementi quadrati che compongono le ante con la morbidezza dell'ecopelle che le riveste. Il modo moderno di essere romantici.

The preciousness of a collection that also lies in the particular choice of materials used. The Soft door is an effective aesthetic synthesis: it combines the strong sign of the square elements that make up the doors with the softness of the eco-leather that covers them. The modern way to be romantic.







Armadio ad ante battenti Soft, impreziosito da inserti imbottiti in ecopelle Barbara BC10. Lo spazio tra i due armadi ospita una nicchia Vanity con ripiano a cassettera laccato Argilla, pannelli e ripiani a giorno in finitura Rovere Caramel. L'interno degli armadi è in finitura Canvas e le spalle sono in finitura Rovere Caramel.

Wardrobe with Soft hinged doors, embellished with Barbara BC10 eco-leather padded inserts. The space between the two wardrobes houses a Vanity niche with an Argilla lacquered chest of drawers, panels and open shelves in Rovere Caramel finish. The inside of the wardrobes is in a Canvas finish and the sides are in a Rovere Caramel finish.



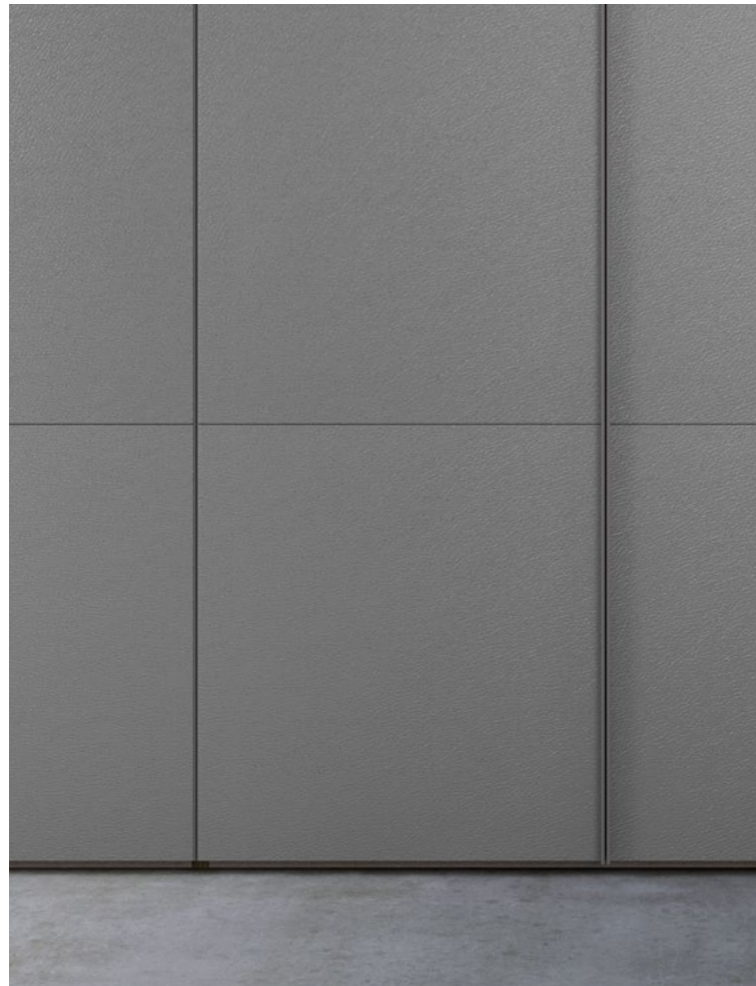

Le ante Soft sono composte da moduli quadrati rivestiti in morbida ecopelle, in queste pagine rappresentata nella finitura Beige.

The Soft doors are made up of square modules covered in soft eco-leather, shown in these pages in the Beige finish.



## ANTA DOUBLE

Un effetto visivo che conferisce dinamicità alla superficie della composizione: l'anta Double è caratterizzata dalla scelta bicromatica delle finiture. Rappresenta una volontà progettuale di interrompere l'unicità della facciata; è una scelta che l'impiego di una maniglia di forte presenza tende ad accentuare.

A visual effect that gives dynamism to the surface of the composition: the Double door is characterized by the choice of two-tone finishes. It represents a design will to interrupt the uniqueness of the facade; it is a choice that the use of a handle with a strong presence tends to accentuate.







Armadio con ante Double in doppia finitura: parte alta in legno laccato finitura Fango e parte bassa in finitura Canvas. Maniglia in tinta laccata finitura Fango. L'interno è in finitura Canvas e attrezzato con cassettera ed elemento contenitore alveare.

Wardrobe with Double doors in double finish: upper part in lacquered wood with Fango finish and lower part in Canvas finish. Handle in Fango finish lacquered color. The interior is in Canvas finish and equipped with a chest of drawers and a pigeonhole container element.

A pagina seguente: variante di finitura con parte alta dell'anta in legno laccato finitura Fango e parte bassa in finitura Rovere Caramel.

On the following page: finish variant with the upper part of the door in lacquered wood in Fango finish and the lower part in Rovere Caramel finish.





**Variante monofinitura**

In questa variante, le ante Double sono in finitura melaminico Calce e maniglia laccata finitura Ghiaccio.

**Single-finish variant**

In this variant, the Double doors are in Calce melamine finish and Ghiaccio finish lacquered handle.







## ANTA FIT

L'anta Fit è in grado di regalare alla composizione un'immagine di eleganza sofisticata, indubbiamente interpretata in senso contemporaneo. La valenza moderna di questa soluzione risiede anche nell'impiego di una maniglia a incasso e dalla collocazione centrale delle ante a scomparsa Ghost in vetro.

The Fit door is able to give the composition an image of sophisticated elegance, undoubtedly interpreted in a contemporary sense. The modern value of this solution also lies in the use of a recessed handle and the central location of the Ghost glass retractable doors.







Armadio con anta Fit in vetro laccato Fango e maniglia a incasso con finitura interna in tinta. L'interno dell'armadio è in finitura Canvas. L'anta a scomparsa Ghost in vetro Fumé, con nuovo sistema scorrevole senza binari, separa la cabina armadio dalla camera da letto.

Wardrobe with Fit door in Fango lacquered glass and recessed handle with matching internal finish. The inside of the wardrobe is in Canvas finish. The Ghost retractable door in Fumé glass, with a new sliding system without tracks, separates the walk-in wardrobe from the bedroom.

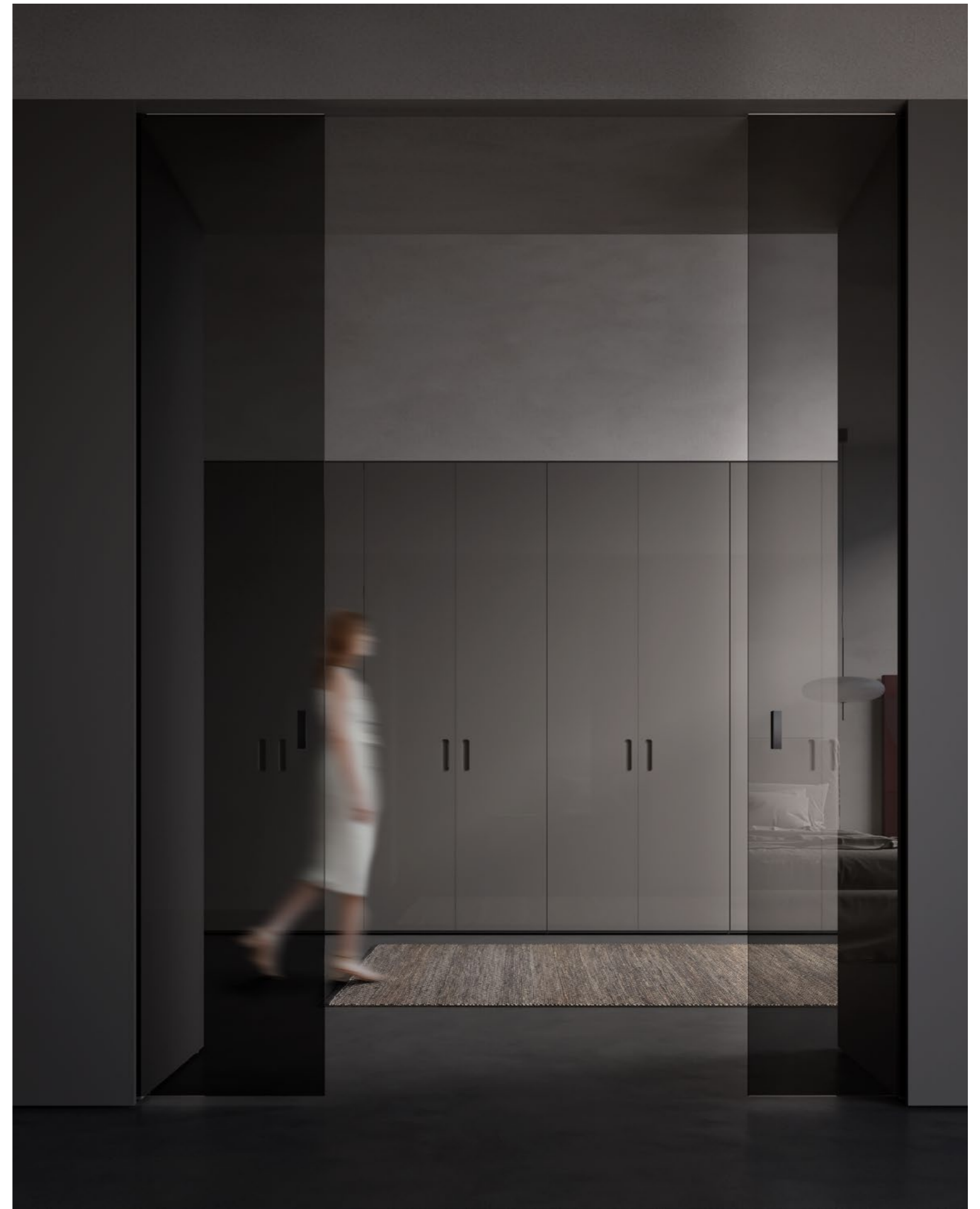

## ANTA LINE + MANIGLIA DUO

Un'interpretazione rigorosa dello spazio, un utilizzo sapiente delle materie prime. Anta Line e maniglia Duo: una perfetta convivenza estetica. L'effetto complessivo è certamente affascinante: il modo migliore di dare intensità e valore al nostro universo privato.

A rigorous interpretation of space, a skillful use of raw materials. Line door and Duo handle: a perfect aesthetic coexistence. The overall effect is certainly fascinating: the best way to give intensity and value to our private universe.





Armadio con ante Line a specchio  
finitura Fumé e maniglia Duo in  
finitura Ghisa Metal. L'interno  
dell'armadio è in finitura Canvas.

Wardrobe with Line mirror doors  
in Fumé finish and Duo handle in  
Ghisa Metal finish. The inside of the  
wardrobe is in Canvas finish.





## ANTA ROW

Una scelta compositiva che integra nella stessa composizione elementi funzionali destinati a svolgere servizi differenti. La continuità della facciata dell'armadiatura è interrotta dalle nicchie variamente interpretabili sul piano della fruizione e dell'abbinamento dei materiali.

A compositional choice that integrates functional elements intended to perform different services in the same composition. The continuity of the wardrobe facade is interrupted by the niches which can be interpreted variously in terms of use and the combination of materials.





Sistema di armadi in nicchia con anta Row in legno laccato finitura Titanio e maniglie laccate finitura Titanio. Il vano trucco con cassetto portaoggetti e luce led integrata è in legno finitura Noce Louisiana. L'interno dell'armadio è in finitura Canvas.

System of niche wardrobes with Row door in lacquered wood with Titanium finish and lacquered handles with Titanium finish. The make-up compartment with storage drawer and integrated LED light is in wood with a Noce Louisiana finish. The inside of the wardrobe is in Canvas finish.

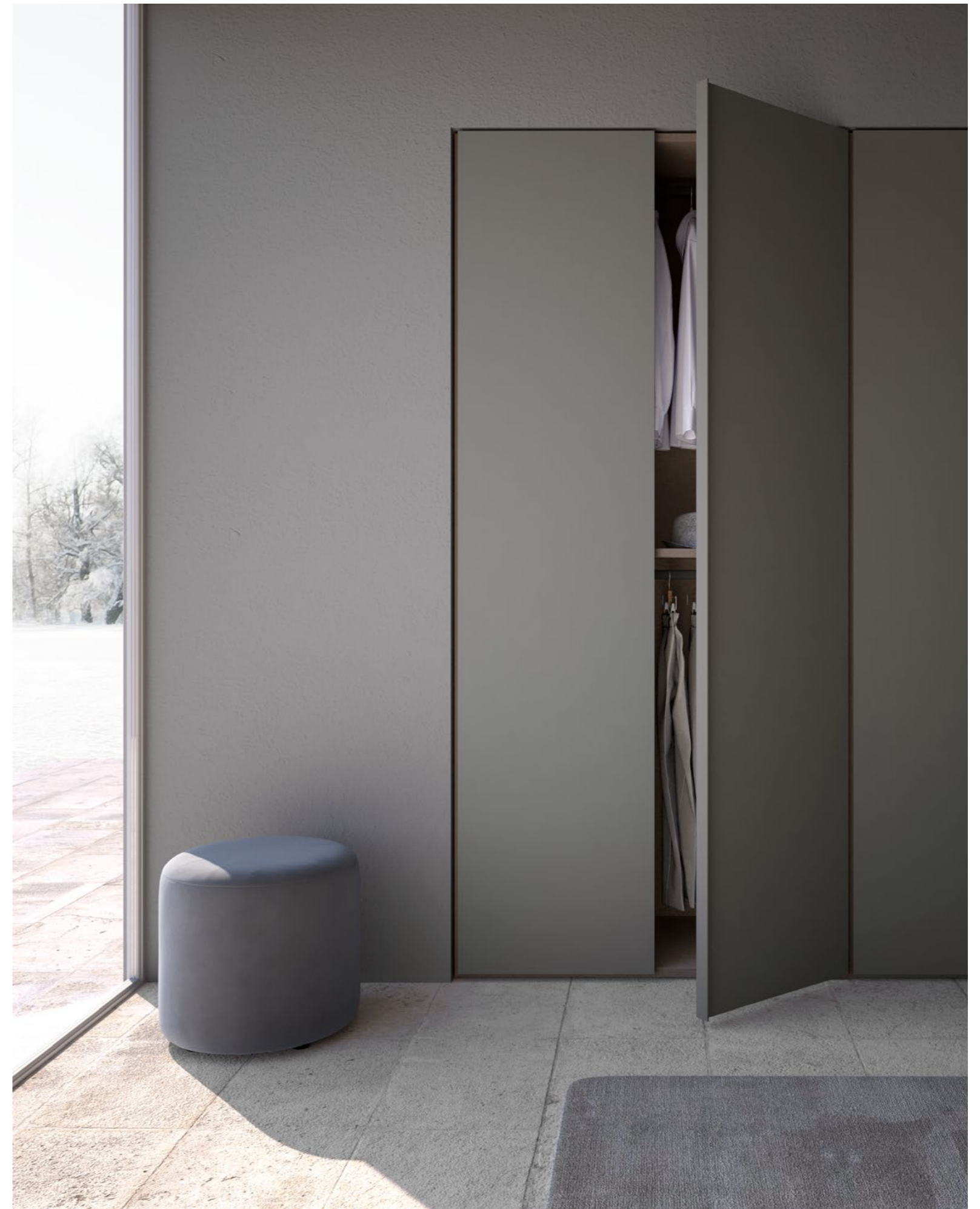



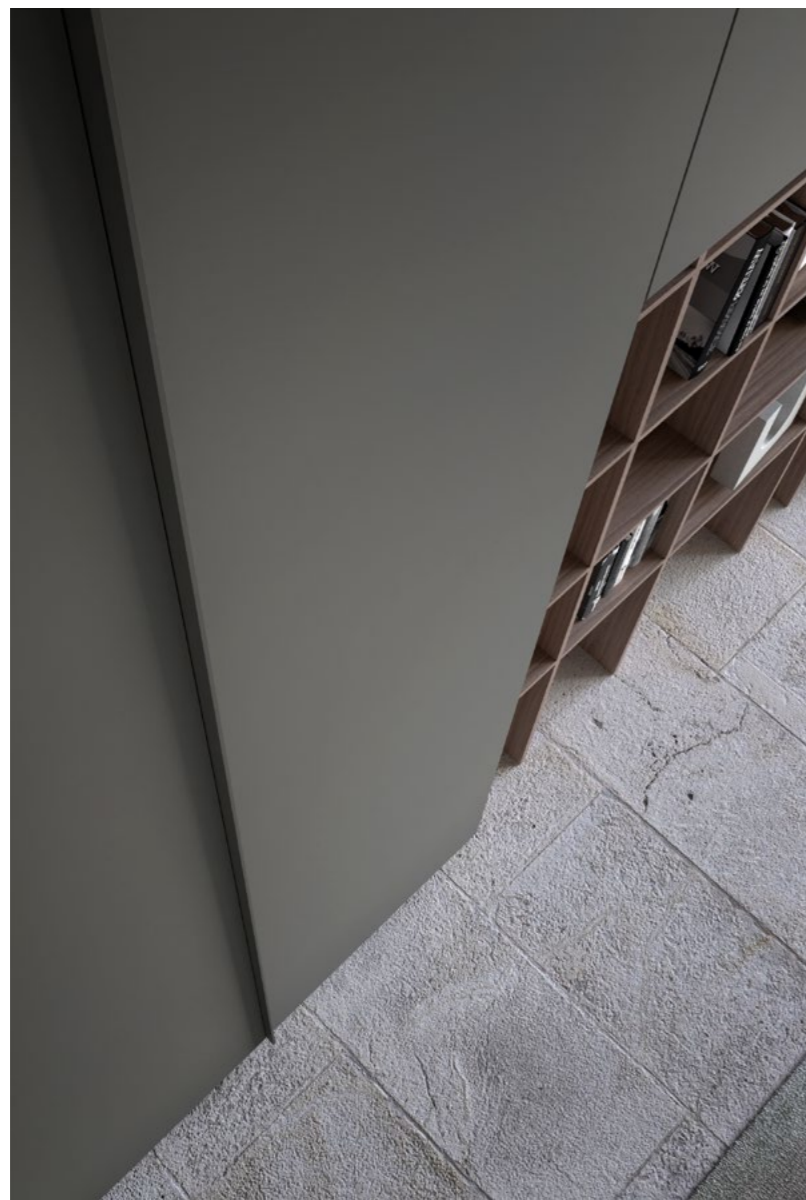

La struttura a ponte con ante a battente in legno laccato finitura Titanio accoglie una sezione libreria in finitura Noce Louisiana con scomparti di dimensioni varie.

The overhead unit structure with hinged doors in Titanio finish lacquered wood houses a bookcase section in Noce Louisiana finish with compartments of various sizes.



**Variante appenderia**

In questa variante, una nicchia in finitura Rovere Caramel attrezzata con tubo appendiabiti è inserita tra l'armadio a ponte e due cassetti in legno laccato finitura Titanio.

**Hanger variant**

In this variant, a niche in Noce Louisiana finish equipped with a clothes hanging rail is inserted between the overhead unit wardrobe and the two drawers in Titanium finish lacquered wood.



## ANTA JOINT

Un segno estetico forte attraversa la composizione in senso verticale, creando una originale architettura formale caratterizzata dalla scansione seriale di elementi visivi paralleli. L'effetto d'immagine che si ottiene rappresenta una scenografia privata con uno spirito decisamente attuale e tipicamente metropolitano.

A strong aesthetic sign crosses the composition vertically, creating an original formal architecture characterized by the serial scanning of parallel visual elements. The image effect obtained represents a private scenography with a decidedly current and typically metropolitan spirit.







Armadio con ante a tutta altezza  
Joint in legno finitura Alaska, con  
maniglia a incasso laccata Ghiaccio.  
L'interno dell'armadio è in finitura  
Rovere Caramel.

Wardrobe with full-height Joint  
doors in Alaska finish wood, with  
Ghiaccio lacquered recessed handle.  
The inside of the wardrobe is in  
Rovere Caramel finish.





## ANTA LINE + MANIGLIA EGO

La solida e concreta razionalità di un'armadiatura a tutta altezza con anta battente Line in legno laccato o nobilitato: una scelta che conferisce all'ambiente notte un fascino molto moderno. La maniglia applicata Ego contribuisce a dare alla composizione un'immagine di rigore e di efficienza.

The solid and concrete rationality of a full-height wardrobe with Line hinged doors in lacquered or melamine wood: a choice that gives the bedroom a very modern charm. The applied Ego handle helps to give the composition an image of rigor and efficiency.







Armadio con ante Line a tutta altezza in legno laccato finitura Cenere con maniglia applicata Ego in finitura Ghisa Metal. L'interno dell'armadio è in finitura Canvas.

Wardrobe with full-height Line doors in lacquered wood in Cenere finish with applied Ego handle in Ghisa Metal finish. The inside of the wardrobe is in Canvas finish.



## ANTA RETURN

Il piacere tutto personale di poter riporre le nostre cose in modo ordinato in una armadiatura funzionale, sapendo che quando si cerca una camicia, una gonna o una cintura la troveremo sicuramente al posto giusto. La maniglia è un elemento funzionale e, insieme, un importante segno estetico.

The entirely personal pleasure of being able to store our belongings in an orderly manner in a functional wardrobe, knowing that when we are looking for a shirt, a skirt or a belt, we will certainly find it in the right place. The handle is a functional element and, at the same time, an important aesthetic sign.





Armadio con ante Return a tutta altezza in legno laccato finitura Ghiaccio e maniglia laccata finitura Ghiaccio. La sezione angolare ospita capienti ripiani che, come l'interno dell'armadio, sono in finitura Calce. La cabina a cremagliera frontale è regolabile nelle tre direzioni ed è attrezzata con portascarpe inclinato.

Wardrobe with full-height Return doors in lacquered wood with Ghiaccio finish and Ghiaccio lacquered handle. The corner section houses large shelves which, like the inside of the wardrobe, are in Calce finish. The front rack cab is adjustable in three directions and is equipped with an inclined shoe shelves.





## ANTA LINE + MANIGLIA SLOT

Una composizione angolare attrezzata con un'ampia cabina e dotata di maniglie Slot. Una scelta ricca di soluzioni, capace di unire le esigenze organizzative dello spazio delle nostre case ad un'interpretazione elegante e piacevole dello stile contemporaneo.

An angular composition equipped with a large walk-in wardrobe and equipped with Slot handles. A choice full of solutions, capable of combining the organizational needs of the space of our homes with an elegant and pleasant interpretation of contemporary style.







Armadio angolare con ante Line in melaminico Tortora, attrezzato con un'ampia cabina ad angolo con interno in finitura Canvas. Maniglie Slot finitura Ghisa Metal.

Corner wardrobe with Line doors in Tortora melamine, equipped with a large corner wardrobe with interior in Canvas finish. Slot handles in Ghisa Metal finish.





L'elemento terminale dell'armadio è attrezzato con vani a giorno in melaminico Tortora, vaschette porta-oggetti in metallo verniciato Tortora e tubi appendiabiti laccati finitura Ghisa Metal.

The end element of the wardrobe is equipped with open compartments in Tortora melamine, storage trays in Tortora painted metal and lacquered clothes hanging rails with a Ghisa Metal finish.



## ANTA LINE + MANIGLIA TRAPEZIO

Una composizione che applica concretamente il principio dell'arredamento come funzionalità: questa soluzione, in parte armadio battente bifacciale e in parte cabina armadio, rende confortevole la nostra casa e agevola la vita nelle operazioni quotidiane. Anche la maniglia Trapezio, con la sua solida concretezza, sposa questa visione.

A composition that concretely applies the principle of furnishing as functionality: this solution, partly double-sided hinged wardrobe and partly walk-in wardrobe, makes our home comfortable and makes life easier in daily operations. Even the Trapezio handle, with its solid concreteness, marries this vision.









Armadio bifacciale con ante Line in legno laccato Tortora, maniglia Trapezio laccata Ghisa Metal e interno in finitura Canvas. Le porte scorrevoli Dea in vetro Fumé e telaio in finitura Ghisa Metal delimitano la cabina che è allestita con sistema a cremagliera frontale, regolabile nelle tre direzioni e attrezzata con portapantaloni estraibile ed elemento a crociera. La cabina è in finitura Canvas.

Double-sided wardrobe with Line doors in Tortora lacquered wood, Trapezio handle in Ghisa Metal lacquer and interior in Canvas finish. The Dea sliding doors in Fumé glass and frame in Ghisa Metal finish delimit the wardrobe, which is set up with a front rack system, adjustable in three directions and equipped with a pull-out trouser rack and cross element. The cabin is in Canvas finish.





## ANTA RETURN

Un armadio posto al centro della stanza, con apertura e funzionalità su entrambi i lati. Una composizione caratterizzata dal dinamismo: nella varietà delle altezze delle ante, nell'alternarsi dei volumi, nella varietà cromatica, negli elementi come cassettiere e porta tv girevole che interrompono la continuità della facciata.

A wardrobe placed in the middle of the room, with openness and functionality on both sides.

A composition characterized by dynamism: in the variety of heights of the doors, in the alternation of volumes, in the chromatic variety, in the elements such as chests of drawers and revolving TV holder that interrupt the continuity of the facade.











Armadio con ante Return in melaminico Calce con maniglia laccata in finitura Fango. Colonne con cassetti e vano porta TV girevole laccati finitura Fango.

Wardrobe with Return doors in Calce melamine with lacquered handle in Fango finish. Tall units with drawers and revolving TV holder lacquered in Fango finish.



**Armadi con anta scorrevole**

Una soluzione che risolve, insieme, un'esigenza di tipo estetica e una di tipo funzionale. Gli armadi con anta scorrevole, infatti, annullano il problema dell'ingombro delle ante, ma garantiscono anche una estrema pulizia estetica alla parte frontale dell'armadio. Le armadiature Adok sono sempre dotate di meccanismi tecnici capaci di garantire elevati standard qualitativi che durano nel tempo. Specie con questa tipologia di apertura, l'innovazione tecnologica è particolarmente ricercata: l'apertura e la chiusura dell'anta sono rallentate magneticamente.

**Sliding wardrobes**

A solution that solves both an aesthetic and a functional need. The wardrobes with sliding doors, in fact, eliminate the problem of the dimensions of the doors, but also guarantee an extremely clean aesthetic to the front part of the wardrobe. Adok wardrobes are always equipped with technical mechanisms capable of guaranteeing high quality standards that last over time. Especially with this type of opening, technological innovation is particularly sought after: the opening and closing of the door are magnetically slowed down.

02 &gt;

Anta  
scorrevole  
Sliding  
door

## ANTA RITMO

L'armadio come elemento architettonico, che segna e definisce l'organizzazione dello spazio. Grazie alla sua spiccata personalità, l'armadio con anta scorrevole Ritmo diventa l'elegante protagonista dell'ambiente notte. Le ante sono suddivise in due parti che creano un particolare effetto scenografico.

The wardrobe as an architectural element, which marks and defines the organization of space. Thanks to its strong personality, the Ritmo wardrobe with sliding door becomes the elegant star of the bedroom. The doors are divided into two parts which create a particular scenographic effect.





Armadio con ante Ritmo scorrevoli e spalle in legno laccato finitura Cenere con maniglia in finitura Selva. Le ante rallentano magneticamente in apertura e chiusura. La zona notte e la zona bagno sono separate dalla porta scorrevole a scomparsa Dea in vetro.

Wardrobe with Ritmo sliding doors and sides in Cenere finish lacquered wood with handle in Selva finish. The doors magnetically slow down when opening and closing. The sleeping area and the bathroom area are separated by the Dea sliding glass door.





## ANTA MONDRIAN

Un piacevole gioco geometrico, un'interpretazione artistica dell'anta: con la sua varietà cromatica organizzata con elementi decorativi orizzontali o verticali, Mondrian garantisce una valenza estremamente originale alla facciata dell'armadiatura, che si trasforma in un moderno quadro d'avanguardia a tutta parete.

A pleasant geometric game, an artistic interpretation of the door: with its chromatic variety organized with horizontal or vertical decorative elements, Mondrian guarantees an extremely original value to the facade of the wardrobe, which transforms into a modern avant-garde painting wall.





Armadio in nicchia con ante Ritmo scorrevoli in legno laccato finitura Cenere e dettaglio geometrico laccato finitura Tortora. L'apertura e la chiusura delle ante sono rallentate grazie ad un meccanismo magnetico. La maniglia in finitura Cenere è applicata a tutta altezza. L'interno dell'armadio è in finitura Canvas.

Niche wardrobe with Ritmo sliding doors in Cenere finish lacquered wood and Tortora finish lacquered geometric detail. The opening and closing of the doors are slowed down thanks to a magnetic mechanism. The handle in Cenere finish is applied to the full height. The inside of the wardrobe is in Canvas finish.

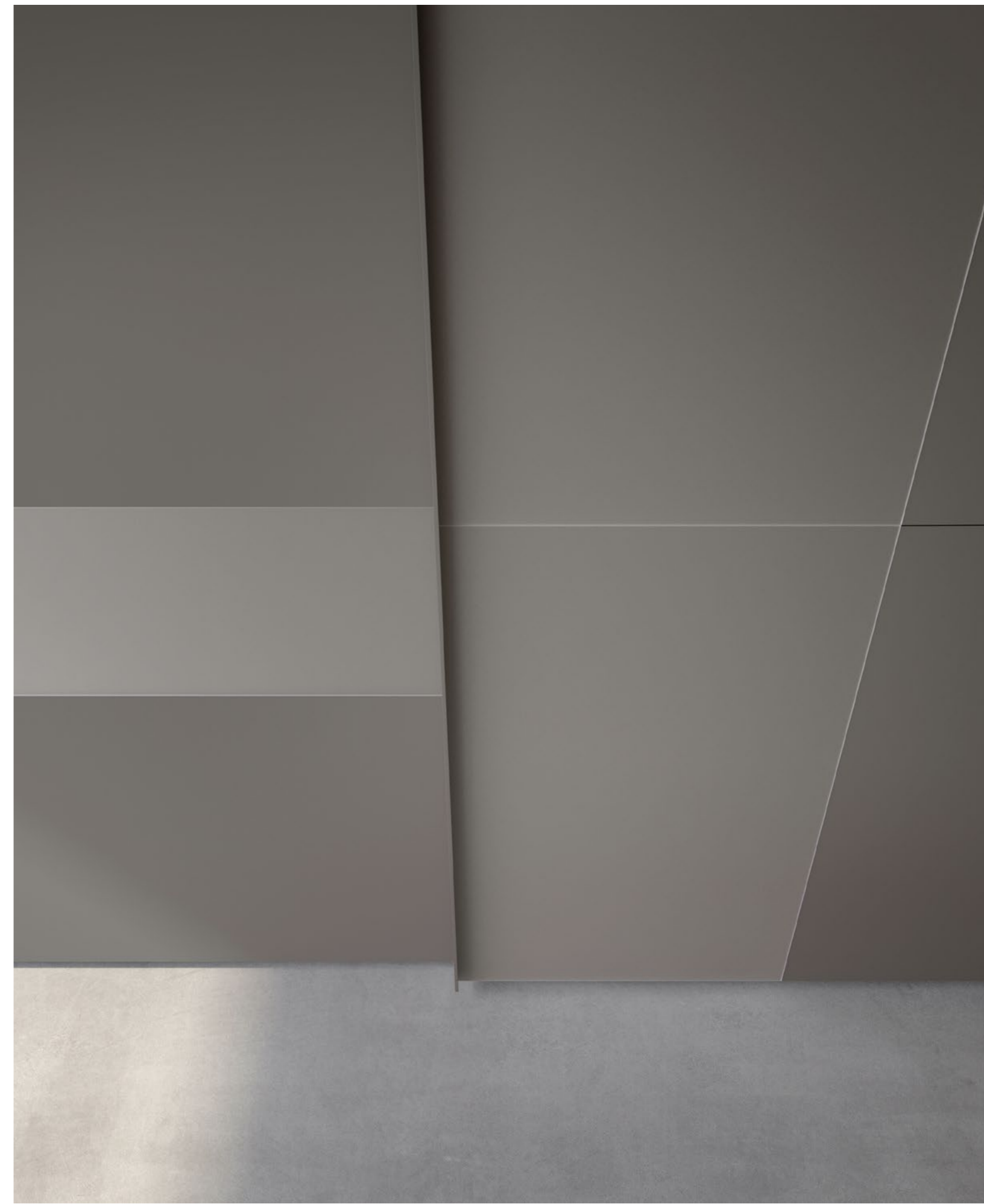



Il motivo decorativo geometrico è disponibile in diverse combinazioni: fasce verticali, fasce orizzontali oppure fasce alternate (come a pagina precedente).

The geometric decorative motif is available in different combinations: vertical bands, horizontal bands or alternating bands (as on the previous page).

## ANTA PLANE

Un volume importante come un armadio, con l'anta Plane scorrevole in vetro e telaio in alluminio, assume una connotazione decisamente diversa: con gli interni che creano un originale gioco plastico dei volumi, è una composizione che significa bellezza, leggerezza, trasparenza, eleganza.

An important volume like a wardrobe, with the Plane sliding glass door and aluminum frame, takes on a decidedly different connotation: with the interiors that create an original plastic play of volumes, it is a composition that signifies beauty, lightness, transparency, elegance.







Armadio con anta Plane scorrevole in vetro Fumé e telaio in alluminio finitura Ghisa Metal. Anta con apertura e chiusura rallentata magneticamente. L'interno dell'armadio è in finitura Canvas.

Wardrobe with Plane sliding door in Fumé glass and aluminum frame with Ghisa Metal finish. Door with magnetically slowed down opening and closing. The inside of the wardrobe is in Canvas finish.



## ANTA SHINE

L'anta Shine denota la versatilità progettuale delle aperture scorrevoli della collezione armadi di Adok. A caratterizzare questa soluzione sono le ante che presentano, nella parte centrale, gli inserti orizzontali in vetro laccato. Un modo elegante di coniugare funzionalità e prestigio.

The Shine door denotes the design versatility of the sliding doors in the Adok wardrobe collection. This solution is characterized by the doors which have horizontal inserts in lacquered glass in the central part. An elegant way to combine functionality and prestige.





Armadio scorrevole con anta Shine in finitura melaminico Fango con inserto orizzontale in vetro laccato Fango. Maniglia in metallo laccato Fango, che accompagna la fascia orizzontale. L'apertura e la chiusura dell'anta sono rallentate magneticamente.

Sliding wardrobe with Shine door in Fango melamine finish with horizontal insert in Fango lacquered glass. Handle in Fango lacquered metal, which accompanies the horizontal band. The opening and closing of the door are magnetically slowed down.



## ANTA SQUARE

Un'apertura caratterizzata da una scelta formale con una identità stilistica di grande riconoscibilità: l'anta Square con maniglia a tutta altezza ha un disegno che la suddivide in due grandi quadrati. Una soluzione di forte attualità, che adotta un linguaggio estetico capace di dare all'ambiente una valenza decisamente moderna.

An opening characterized by a formal choice with a highly recognizable stylistic identity: the Square door with full-height handle has a design that divides it into two large squares. A highly topical solution, which adopts an aesthetic language capable of giving the environment a decidedly modern value.







Armadio scorrevole con anta Square in finitura Specchio Bronzo, con apertura e chiusura rallentata magneticamente. Le maniglie sono a tutta altezza e in finitura Ghisa Metal. L'interno dell'armadio è in finitura Canvas.

Sliding wardrobe with Square door in Specchio Bronzo finish, with magnetically slowed down opening and closing. The handles are full height and in Ghisa Metal finish. The inside of the wardrobe is in Canvas finish.

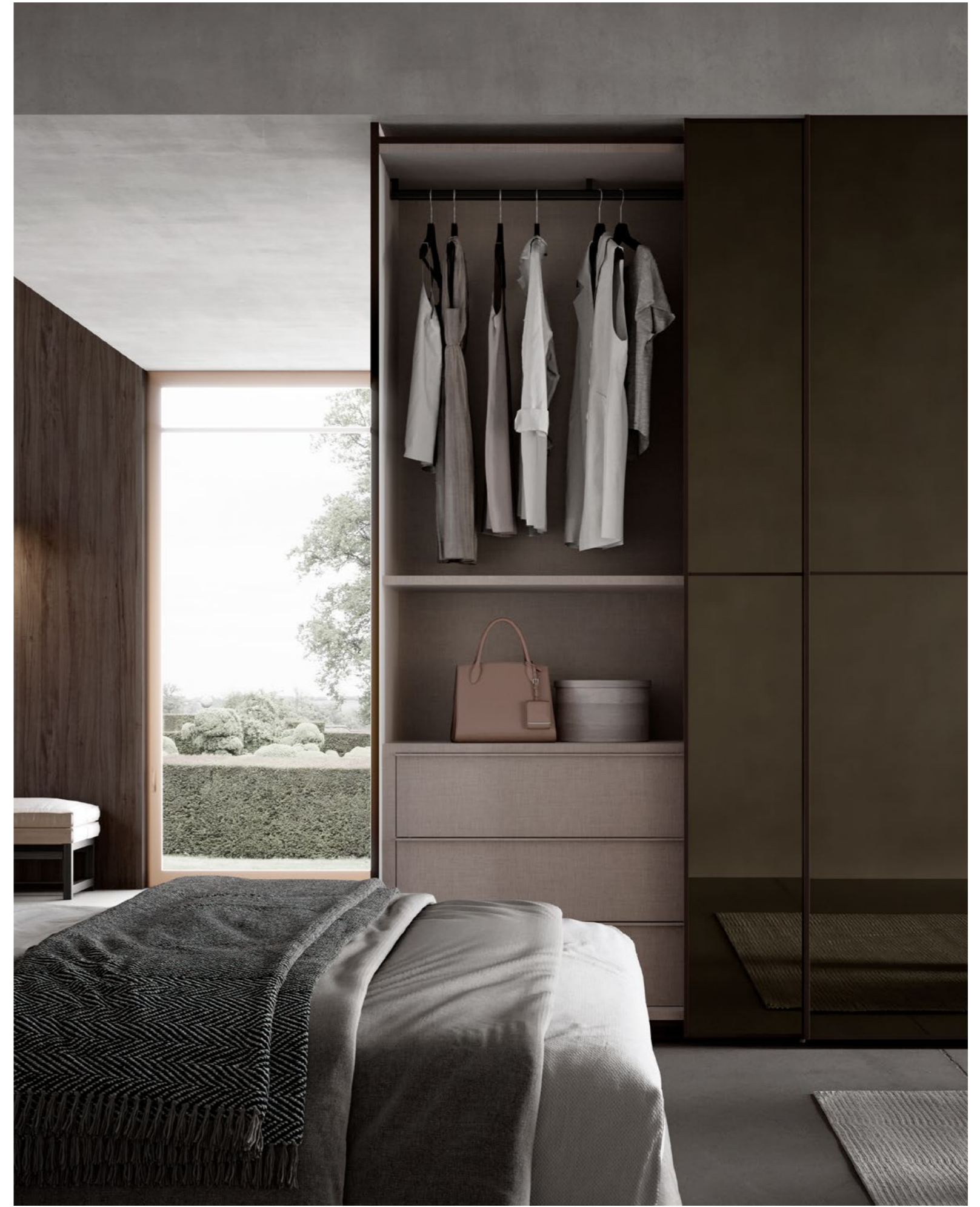
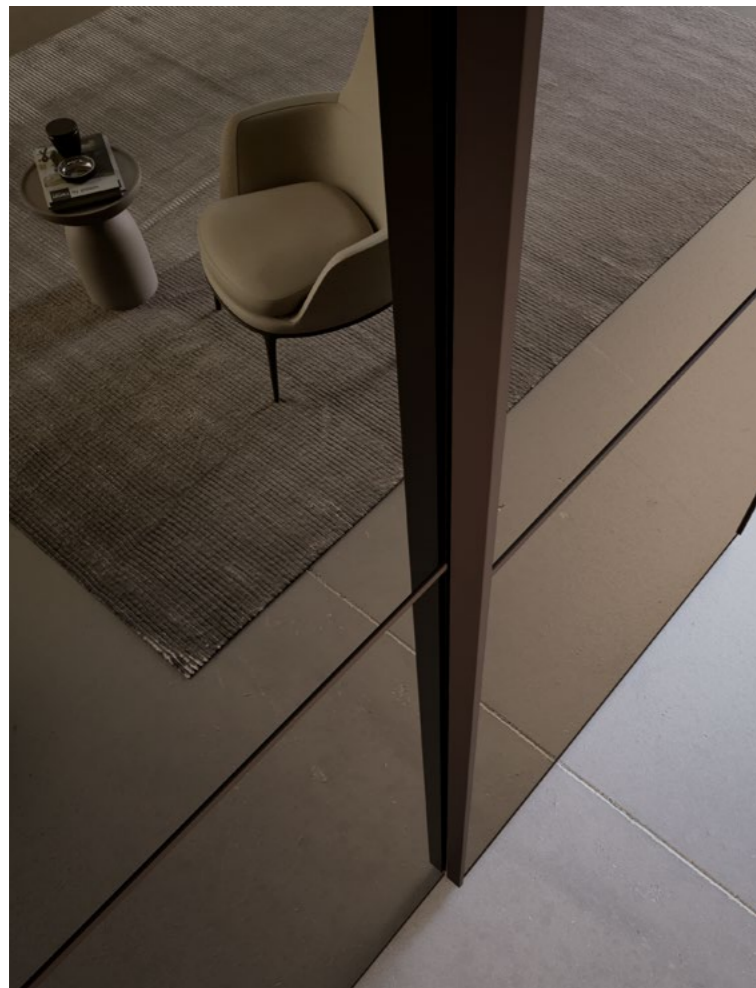

**Cabine Armadio**

Entrare nella nostra cabina armadio significa accedere a un microcosmo che rappresenta un universo privato che riflette le nostre passioni e la nostra storia. È uno spazio molto personale perché mostra gusti e preferenze. E allora, l'arredo di una cabina armadio non deve rispondere solo ai più moderni criteri di funzionalità, ma essere uno spazio capace di interpretare al meglio la nostra individualità: servizi, oggetti, finiture e attrezzature sono tutti dettagli che raccontano chi noi siamo.

**Walk-in wardrobes**

Entering our walk-in wardrobe means accessing a microcosm that represents a private universe that reflects our passions and our history. It is a very personal space because it shows tastes and preferences. And so, the furnishing of a walk-in wardrobe must not only meet the most modern criteria of functionality, but must be a space capable of best interpreting our individuality: services, objects, finishes and equipment are all details that tell who we are.

# Cabine Armadio Walk-in closet

03 &gt;

UP&DOWN  
Ambiente / Environment 1

La Cabina Up&Down: un'idea della casa come universo privato, una composizione dedicata alla vita quotidiana e a tutte quelle operazioni variamente collegate all'armadio. Una modernità interpretativa accentuata dall'utilizzo contemporaneo di materiali di varia provenienza stilistica, apparentemente contrastanti. Una scelta che esprime una personalità di indubbia forza.

The Up&Down walk-in wardrobe: an idea of the home as a private universe, a composition dedicated to daily life and to all those operations variously connected to the wardrobe. An interpretative modernity accentuated by the contemporary use of apparently contrasting materials of various stylistic origins. A choice that expresses a personality of undoubted strength.





Cabina Up&Down con pannelli a parete in finitura Rovere Caramel e Specchio Bronzato. Le attrezzature comprendono: tubi appendiabiti in finitura Ghisa Metal, cassettiere in finitura Rovere Caramel e maniglie Ghisa Metal, ripiani inclinati portascarpe finitura Rovere Caramel, contenitori alveari finitura Rovere Caramel.

Up&Down walk-in wardrobe with Rovere Caramel and Specchio Bronzato wall panels. The equipment includes: clothes hanging rails in Ghisa Metal finish, drawer units in Rovere Caramel finish and Ghisa Metal handles, inclined shoe shelves in Rovere Caramel finish, pigeonhole containers in Rovere Caramel finish.





UP&DOWN  
Ambiente / Environment 2

La collezione armadi Atelier Night System di Adok presenta una proposta varia e articolata di tutte le tipologie, e in particolare delle cabine armadio. In questa soluzione, a variare sono i cromatismi, i materiali e le scelte compositive: agli spazi aperti della parte superiore, fanno riscontro le cassettiere a mezza altezza, che rappresentano il vero e proprio baricentro visivo della soluzione.

The Atelier Night System wardrobe collection by Adok presents a varied and articulated proposal of all types, and in particular of walk-in wardrobes. In this solution, the colors, materials and compositional choices vary: the open spaces of the upper part are matched by the half-height chests of drawers, which represent the real visual center of gravity of the solution.





In queste pagine e a pagina precedente: variante della cabina con pannelli in finitura Testa di Moro, mensole, cassettiere e maniglie laccate Granata.

On these pages and on the previous page: version of the walk-in wardrobe with panels in Testa di Moro finish, shelves, drawer units and handles in Granata lacquer finish.



UP&DOWN  
Ambiente / Ambiente 3

Una soluzione affascinante e magica: una interpretazione della cabina Up&Down realizzata attraverso la grande varietà di elementi di servizio e caratterizzata dalla funzionalità dell'isola centrale. Per iniziare bene la giornata rendendo più comodi e piacevoli i nostri riti quotidiani.

A fascinating and magical solution: an interpretation of the Up&Down walk-in wardrobe created through the great variety of service elements and characterized by the functionality of the central island. To start the day right, making our daily rituals more comfortable and pleasant.













Cabina Up&Down con pannelli Canvas e inserto pannello con specchio Bronzo. Mensole e attrezzature in finitura Noce Louisiana, tubi appendiabiti in finitura Ghisa Metal. Cassettiere in finitura Noce Louisiana con maniglie Ghisa Metal. L'isola Domino in finitura Noce Louisiana è attrezzata con scomparti alveari e cassetti con maniglia in finitura Ghisa Metal. Le porte scorrevoli Dea in vetro Fumé e telaio in finitura Ghisa Metal delimitano la cabina.

Up&Down walk-in wardrobe with Canvas panels and panel insert with Bronze mirror. Shelves and equipment in Noce Louisiana finish, clothes hanging rails in Ghisa Metal finish. Chests of drawers in Noce Louisiana finish with Ghisa Metal handles. The Domino Island in Noce Louisiana finish is equipped with pigeonhole compartments and drawers with handle in Ghisa Metal finish. The Dea sliding doors in Fumé glass and frame in Ghisa Metal finish delimit the walk-in wardrobe.



## UP&amp;DOWN

Ambiente / Environment 4

Una interpretazione della cabina Up&Down che sfrutta gli elementi architettonici presenti e consente di realizzare una composizione lineare da parete a parete.

Una soluzione capace di sfruttare al meglio lo spazio disponibile creando un rapporto dinamico e aperto con l'ambiente.

Nella pagina a fianco e a pagina seguente: cabina Up&Down con pannelli verticali in finitura Frassino Normandie e attrezzature in finitura Fango.

An interpretation of the Up&Down walk-in wardrobe that takes advantage of the architectural elements present and allows for the creation of a linear wall-to-wall composition.

A solution capable of making the most of the available space by creating a dynamic relationship and open with the environment.

Facing page and following page: Up&Down walk-in wardrobe with vertical panels in Frassino Normandie finish and equipment in Fango finish.





VERTICAL  
Ambiente / Environment 5

Le ante Dea in vetro scorrono leggere... e si entra in un mondo "Vertical", la cabina armadio con struttura a pali fissati a soffitto e illuminazione integrata a led. Una soluzione di grande versatilità progettuale e che si presta a varie interpretazioni estetiche, grazie alla gamma delle finiture disponibili.

The Dea glass doors slide lightly... and you enter a "Vertical" world, the walk-in wardrobe with a structure with poles fixed to the ceiling and integrated LED lighting. A solution of great design versatility that lends itself to various aesthetic interpretations, thanks to the range of finishes available.







Cabina Vertical con struttura a pali fissati a soffitto e illuminazione integrata a led. Piani in finitura Canvas. Cassettiere in finitura Canvas e maniglia in finitura Ghisa Metal. A pagina seguente: variante di finitura con pannelli e cassettiera laccati Tirreno e maniglie Ghisa Metal. Le porte scorrevoli Dea in vetro Fumé e telaio in finitura Ghisa Metal delimitano la cabina.

Vertical walk-in wardrobe with pole structure fixed to the ceiling and integrated LED lighting. Canvas finish tops. Chests of drawers in Canvas finish and handle in Ghisa Metal finish. On the following page: finishing variant with Tirreno lacquered panels and chest of drawers and Ghisa Metal handles. The Dea sliding doors in Fumé glass and frame in Ghisa Metal finish delimit the walk-in wardrobe.



**Variante di finitura**

Cabina con struttura a pali, tubi appendiabiti e maniglie in finitura Ghisa Metal, ripiani e cassettiere laccati Tirreno.

**Finishing variant**

Walk-in wardrobe with pole structure, clothes hanging rails and handles in Ghisa Metal finish, Tirreno lacquered shelves and chests of drawers.

Informazioni tecniche  
Armadi  
**Technical information**  
**Wardrobes**

## Dimensioni Dimensions

La modularità del sistema armadi Atelier consente di adattarsi a qualsiasi spazio, grazie a quattro diverse altezze e a vani di diverse larghezze, per le versioni ad anta battente, pieghevole e scorrevole.

The modularity of the Atelier wardrobe system allows it to adapt to any space, thanks to four different heights and compartments of different widths, for the hinged, folding and sliding door versions.

### Altezze / Heights



### Profondità / Depth



### Larghezze / Widths

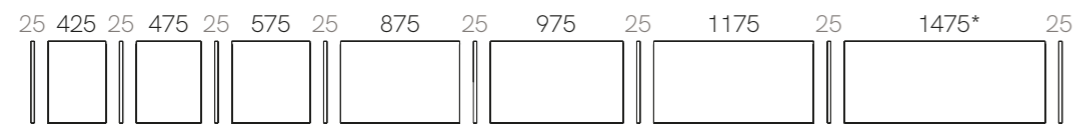

\* solo anta scorrevole sliding door only

### Battente / Hinged

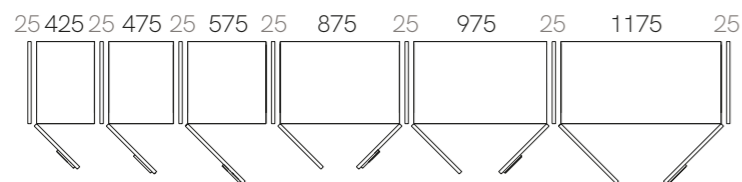

### Pieghevole / Folding

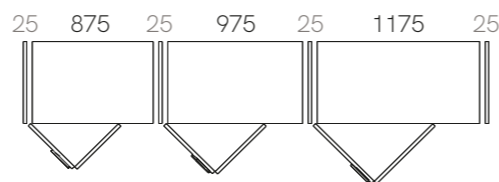

### Scorrevole / Sliding

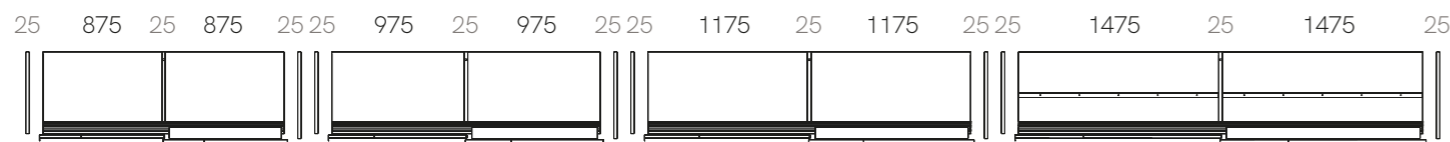

## Componenti struttura Structure components

I vari elementi degli armadi Atelier si compongono per creare il modulo alla base del sistema. Fianchi, schienali, ripiani, coperchi e basi: non serve altro per realizzare un armadio di alta qualità.

The various elements of the Atelier wardrobes come together to create the module at the base of the system. Sides, backs, shelves, covers and bases: that's all you need to make a high-quality wardrobe.

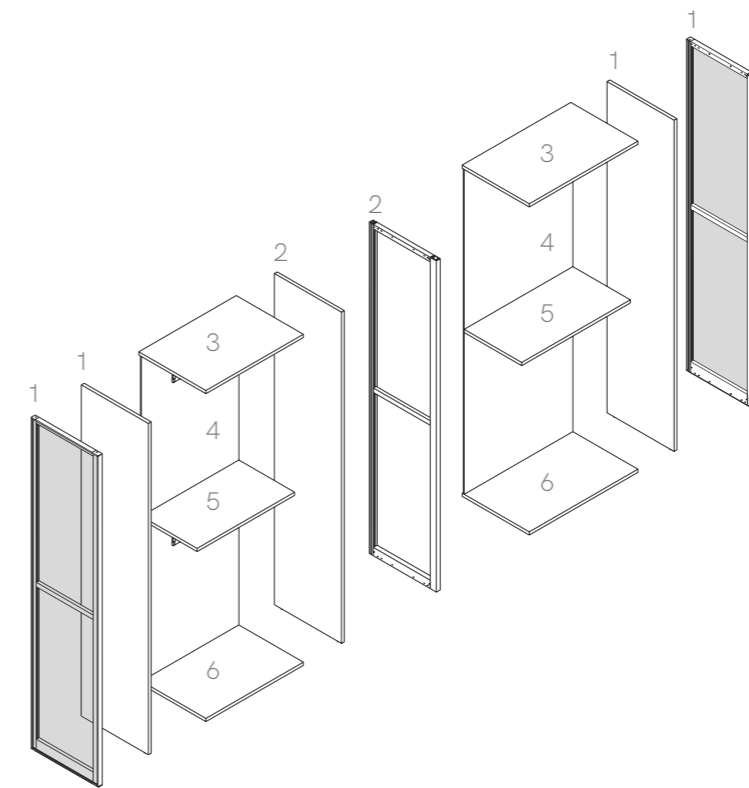

- 1 Fianco laterale
- 2 Fianco centrale
- 3 Coperchio
- 4 Schiena
- 5 Ripiano
- 6 Base

- 1 Lateral side
- 2 Central side
- 3 Cover
- 4 Back
- 5 Shelf
- 6 Base

## Componenti struttura Structure components

### Tipologie fianchi

- 1 Fianco laterale legno bicolore
- 2 Fianco laterale legno monocolore
- 3 Fianco laterale legno laccato esternamente
- 4 Fianco laterale vetro
- 5 Fianco centrale legno
- 6 Fianco centrale telaio

### Sides types

- 1 Bicolor wooden lateral side
- 2 Monochrome wooden lateral side
- 3 Externally lacquered wooden lateral side
- 4 Glazed lateral side
- 5 Wooden central side
- 6 Framed central side

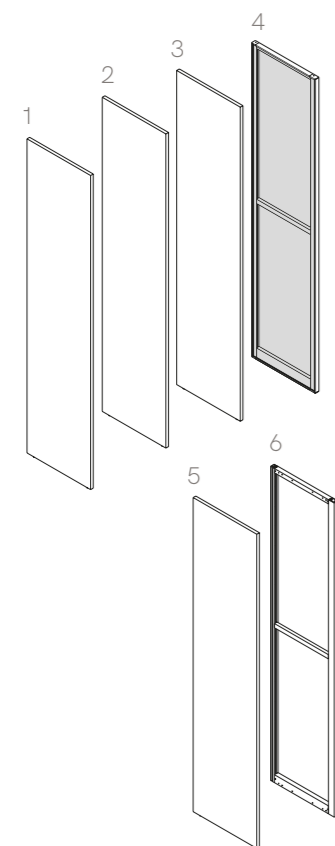

### Nobilitati Melamines

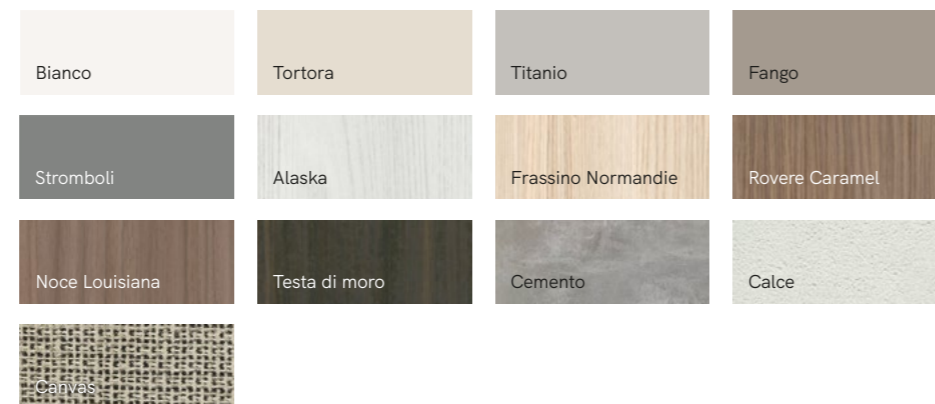

### Colori laccature Lacquer colors



### Colori laccature Metal Metal lacquer colors



### Vetro Glass

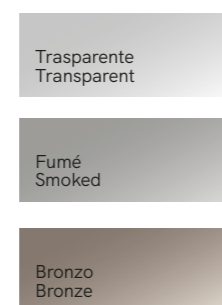

### Vetro acidato Etched glass

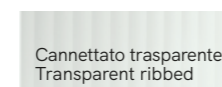
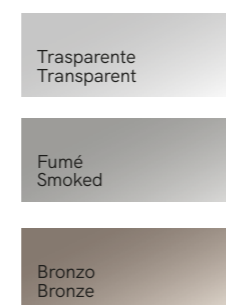

### Tipologia schienali Spessore 8 mm

Back typology  
8 mm thick

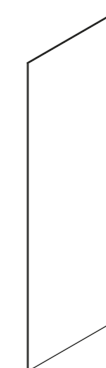

### Tipologia ripiani

- 1 Ripiano legno sp 25 mm
- 2 Ripiano legno sp 38 mm
- 3 Ripiano vetro con telaio

### Shelf typology

- 1 Wooden shelf 25 mm thick
- 2 Wooden shelf 38 mm thick
- 3 Glazed shelf with frame

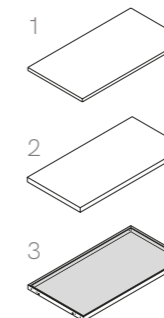

### Tipologia coperchi e basamenti

- 1 Coperchio legno sp 25 mm
- 2 Base legno sp 25 mm

### Cover and base typology

- 1 Wooden cover 25 mm thick
- 2 Wooden base 25 mm thick

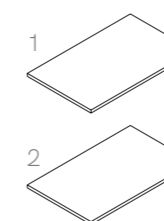

### Nobilitati Melamines

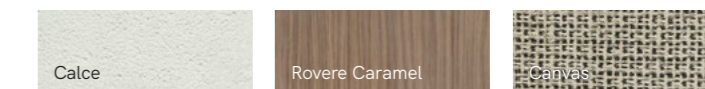

### Nobilitati Melamines

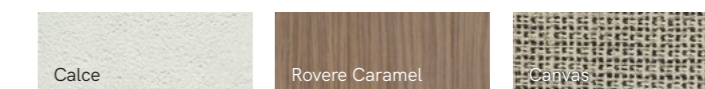

### Vetro Glass

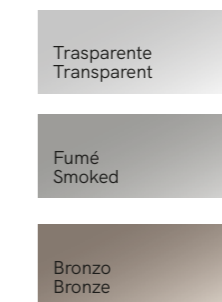

### Nobilitati Melamines

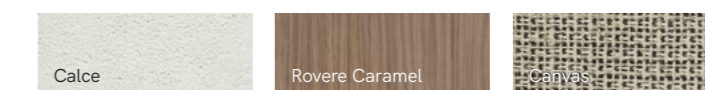

## Tipologia aperture Type of openings

Sono quattro le tipologie di aperture che caratterizzano il sistema armadi Atelier: ad anta battente, ad anta battente abbinata a cassetti, ad anta scorrevole e ad anta pieghevole.

There are four types of openings that characterize the Atelier wardrobe system: hinged door, hinged door combined with drawers, sliding door and folding door.

- 1 Armadio battente
  - 2 Armadio battente con cassetti
  - 3 Armadio scorrevole
  - 4 Armadio pieghevole
- 1 Hinged wardrobe
  - 2 Hinged wardrobe with drawers
  - 3 Sliding wardrobe
  - 4 Folding wardrobe

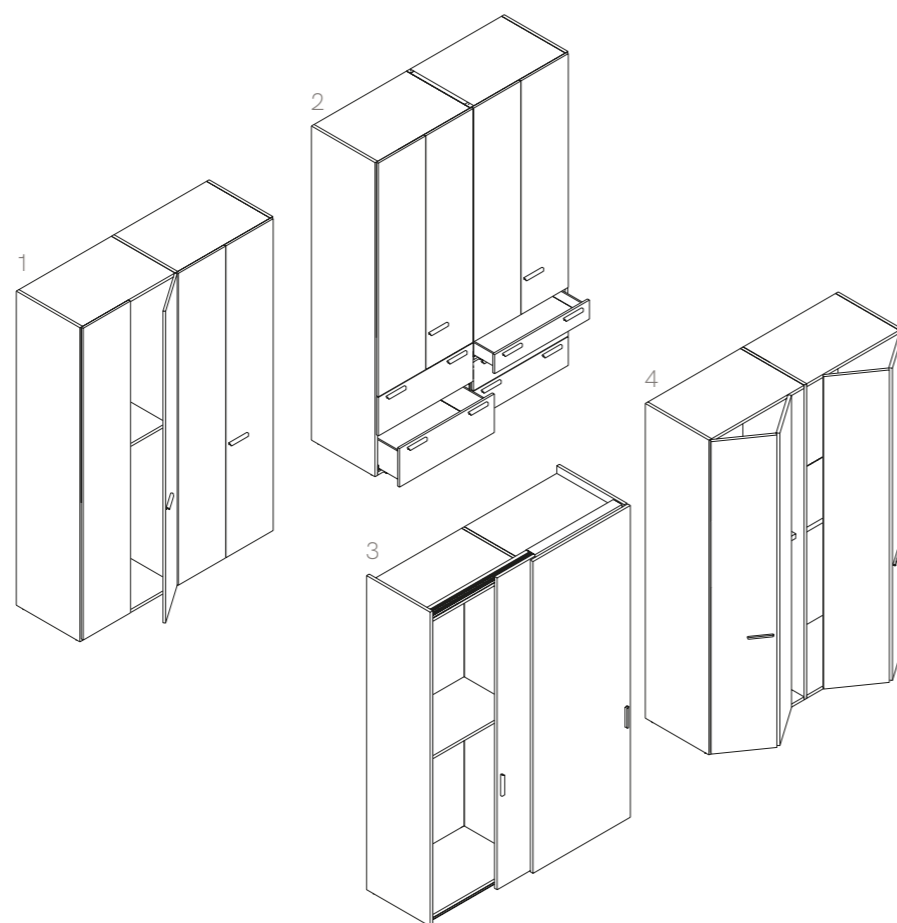

## Integrazione aperture Integration to openings

I moduli con diverse tipologie di apertura sono progettati per integrarsi perfettamente tra loro. Hanno infatti la stessa modularità in altezza e sono disponibili nelle stesse finiture e attrezzature interne.

The modules with different types of opening are designed to integrate perfectly with each other. In fact, they have the same modularity in height and are available in the same finishes and internal equipment.

- 1 Armadio battente
  - 2 Armadio battente a vetro
  - 3 Armadio pieghevole
  - 4 Armadio a giorno
  - 5 Cremagliera
  - 6 Armadio scorrevole
- 1 Hinged wardrobe
  - 2 Glass hinged wardrobe
  - 3 Folding wardrobe
  - 4 Open wardrobe
  - 5 Rack
  - 6 Sliding wardrobe

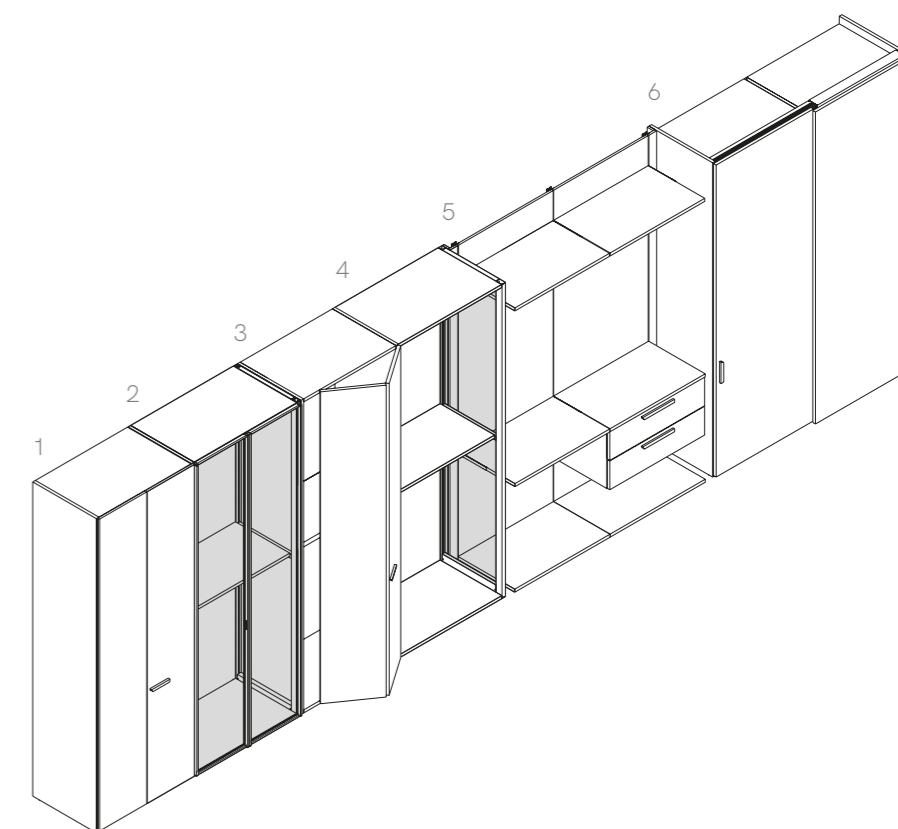

Dettagli struttura / Tipologia aperture  
Structure details / Type of openings



**Fianco laterale monocoloro**  
Monochrome lateral side



**Fianco laterale bicolore**  
Bicolor lateral side



**Fianco laterale vetro**  
Glazed lateral side



**Fianco centrale legno con schiena legno**  
Wooden central side with wooden back



**Fianco centrale a telaio con schiena legno**  
Central framed side with wooden back

Forature  
Drillings



**Foratura fianchi di serie: foro  $\varnothing$  0,5 cm ogni 16 cm**  
Standard side drilling:  $\varnothing$  0.5 cm hole every 16 cm

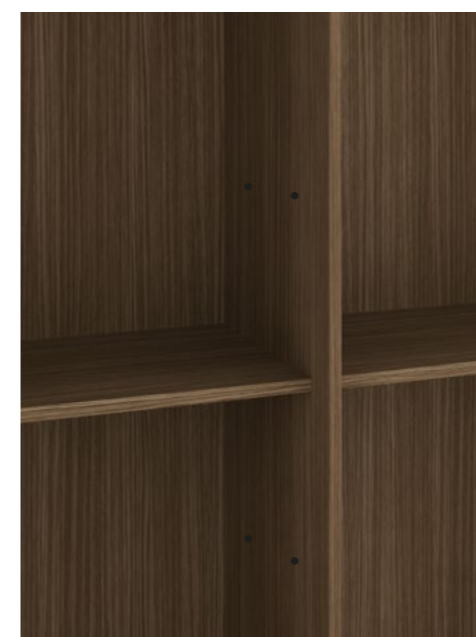

**Foratura fianchi solo su ripiano: foro  $\varnothing$  0,5 cm solo in corrispondenza del ripiano**  
Sides drilling only on the shelf:  $\varnothing$  0.5 cm hole only in correspondence with the shelf

Reggipiano  
Shelf support



Cerniera  
Hinge

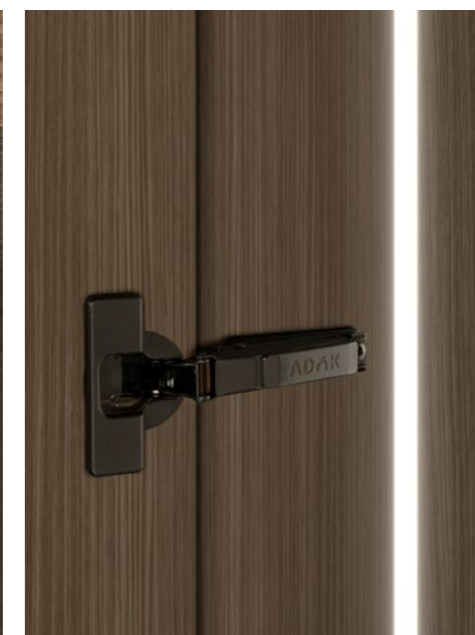

**Cerniera con base orizzontale**  
Hinge with horizontal base

### Soluzioni speciali Special solutions



**Angolo ante battenti**  
Corner hinged doors



**Angolo esterno con ante battenti**  
External corner with hinged doors



**Terminali con ante battenti**  
Terminals with hinged doors



**Terminali obliqui con ante battenti**  
Oblique terminals with hinged doors

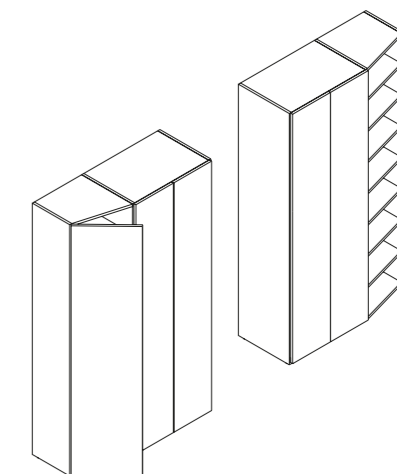
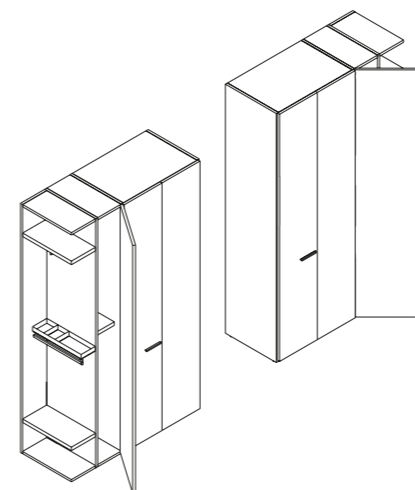
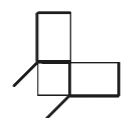
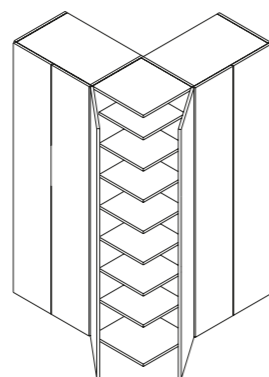
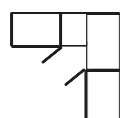
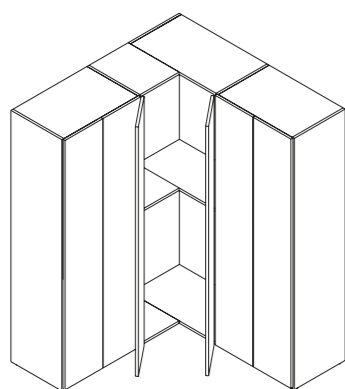

## Soluzioni speciali Special solutions



### Montaggio in nicchia

Tra le soluzioni speciali è incluso il montaggio in nicchia dell'armadiatura.

#### Niche installation

The special solutions include niche installation of the wardrobe.



### Tamponamento

Sono disponibili soluzioni con tamponamenti a chiusura di spazi residui per creare un effetto di continuità con le pareti.

#### Infill

Solutions are available with infill panels to close residual spaces to create an effect of continuity with the walls.



### Taglio a misura

Grazie ai tagli su misura, il sistema Atelier garantisce la massima versatilità, anche in presenza di elementi architettonici particolari.

#### Cut to size

Thanks to the cut to size, the Atelier system guarantees maximum versatility, even in the presence of particular architectural elements.

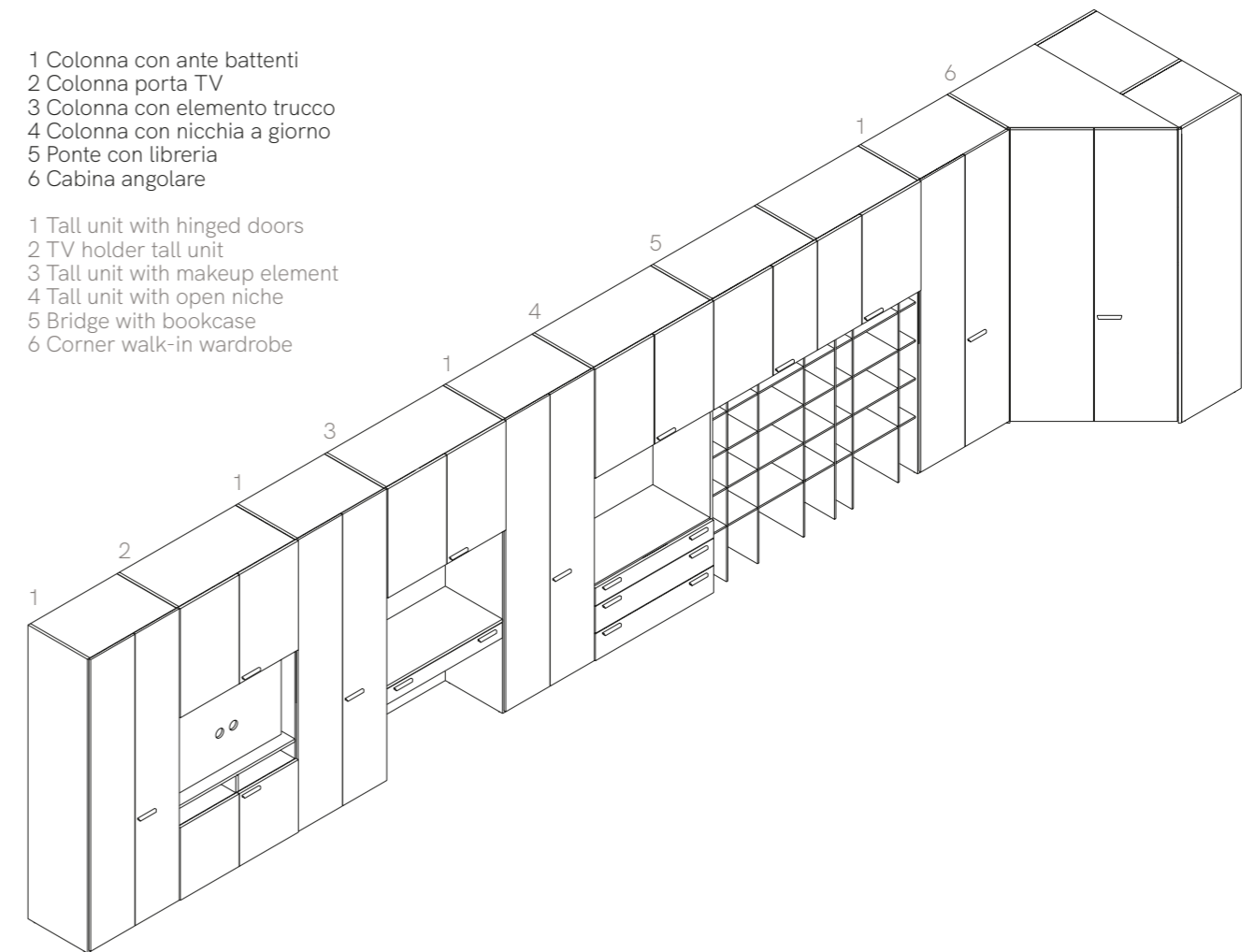

- 1 Colonna con ante battenti
- 2 Colonna porta TV
- 3 Colonna con elemento trucco
- 4 Colonna con nicchia a giorno
- 5 Ponte con libreria
- 6 Cabina angolare

- 1 Tall unit with hinged doors
- 2 TV holder tall unit
- 3 Tall unit with makeup element
- 4 Tall unit with open niche
- 5 Bridge with bookcase
- 6 Corner walk-in wardrobe

### Armadio bifacciale

La soluzione bifacciale è adatta sia come divisorio di ambienti che come armadio a centro stanza, per una innovativa distribuzione degli spazi.

#### Double-sided wardrobe

The double-sided solution is suitable both as a room divider and as a freestanding wardrobe, for an innovative distribution of spaces.

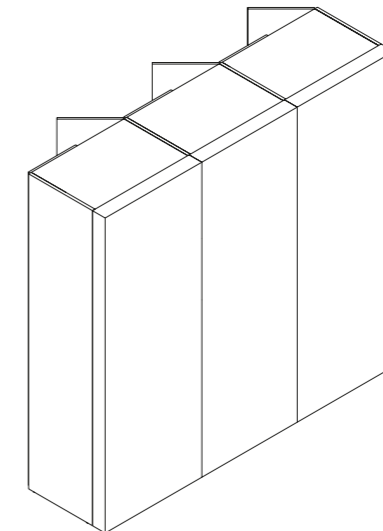

Finiture struttura / Abbinamenti consigliati  
Structure finishes / Recommended combinations



**Schienale:** Calce  
**Cassetti:** Calce  
**Attrezzatura:** Calce  
**Parti metalliche:** Ghisa Metal  
Back: Calce  
Drawers: Calce  
Equipment: Calce  
Metallic parts: Ghisa Metal



**Schienale:** Canvas  
**Cassetti:** Canvas  
**Attrezzatura:** Canvas  
**Parti metalliche:** Ghisa Metal  
Back: Canvas  
Drawers: Canvas  
Equipment: Canvas  
Metallic parts: Ghisa Metal



**Schienale:** Rovere Caramel  
**Cassetti:** Rovere Caramel  
**Attrezzatura:** Rovere Caramel  
**Parti metalliche:** Ghisa Metal  
Back: Rovere Caramel  
Drawers: Rovere Caramel  
Equipment: Rovere Caramel  
Metallic parts: Ghisa Metal



**Schienale:** Rovere Caramel  
**Cassetti:** Canvas  
**Attrezzatura:** Canvas  
**Parti metalliche:** Ghisa Metal  
Back: Rovere Caramel  
Drawers: Canvas  
Equipment: Canvas  
Metallic parts: Ghisa Metal



**Schienale:** Calce  
**Cassetti:** Rovere Caramel  
**Attrezzatura:** Rovere Caramel  
**Parti metalliche:** Ghisa Metal  
Back: Calce  
Drawers: Rovere Caramel  
Equipment: Rovere Caramel  
Metallic parts: Ghisa Metal



**Schienale:** Canvas  
**Cassetti:** Calce  
**Attrezzatura:** Calce  
**Parti metalliche:** Ghisa Metal  
Back: Canvas  
Drawers: Calce  
Equipment: Calce  
Metallic parts: Ghisa Metal

## Organizzazione degli interni Interior organization

- |  |   |   |   |  |  |  |   |
|--|---|---|---|--|--|--|---|
| <b>1</b><br>Tubo appendiabiti<br>Alveare<br>Cassettiera sospesa          | <b>2</b><br>Tubo appendiabiti<br>Alveare<br>Cassettiera<br>in appoggio  | <b>3</b><br>Tubo appendiabiti<br>Alveare<br>Cassettiera<br>in appoggio  | <b>4</b><br>Ripiano<br>Tubo appendiabiti<br>Vassoio<br>Cassettiera<br>in appoggio | <b>5</b><br>Ripiano<br>Tubo appendiabiti<br>Cassettiera<br>in appoggio | <b>6</b><br>Ripiano<br>Tubo appendiabiti<br>Cesto estraibile<br>in tessuto | <b>7</b><br>Ripiano<br>Ripiani portascarpe<br>7<br>Shelf<br>Shoe shelves | <b>8</b><br>Ripiani<br>Vassoio estraibile<br>Vassoio con vaschetta<br>porta cinture |
| 1<br>Clothes hanging rail<br>Pigeonhole<br>Suspended chest<br>of drawers | 2<br>Clothes hanging rail<br>Pigeonhole<br>Standing chest<br>of drawers | 3<br>Clothes hanging rail<br>Pigeonhole<br>Standing chest<br>of drawers | 4<br>Shelf<br>Clothes hanging rail<br>Tray<br>Standing chest<br>of drawers        | 5<br>Shelf<br>Clothes hanging rail<br>Standing chest<br>of drawers     | 6<br>Shelf<br>Clothes hanging rail<br>Fabric pull-out<br>basket            |  | 8<br>Shelves<br>Pull-out tray<br>Tray with belt holder                              |



Organizzazione degli interni / Ante battenti  
Interior organization / Hinged doors

Moduli da 1000 mm e 500 mm  
Finitura Canvas

1000 mm and 500 mm modules  
Canvas finish

Moduli da 1000 mm e 500 mm  
Finitura Rovere Caramel

1000 mm and 500 mm modules  
Rovere Caramel finish



1000

1000

500

1000

1000



1000

1000

1000

1000

500

Organizzazione degli interni / Ante battenti  
Interior organization / Hinged doors

Moduli da 1200 mm  
Finitura Calce

1200 mm modules  
Calce finish



1200

1200

1200

1200

Moduli da 1200 mm  
Finitura Rovere Caramel e Canvas

1200 mm modules  
Rovere Caramel and Canvas finish



1200

1200

1200

1200

Organizzazione degli interni / Ante scorrevoli  
Interior organization / Sliding doors

Moduli da 1500 mm  
Finitura Canvas e Rovere Caramel

1500 mm modules  
Canvas and Rovere Caramel finish



1500

1500

1500

Moduli da 1500 mm  
Finitura Canvas e Rovere Caramel

1500 mm modules  
Canvas and Rovere Caramel finish

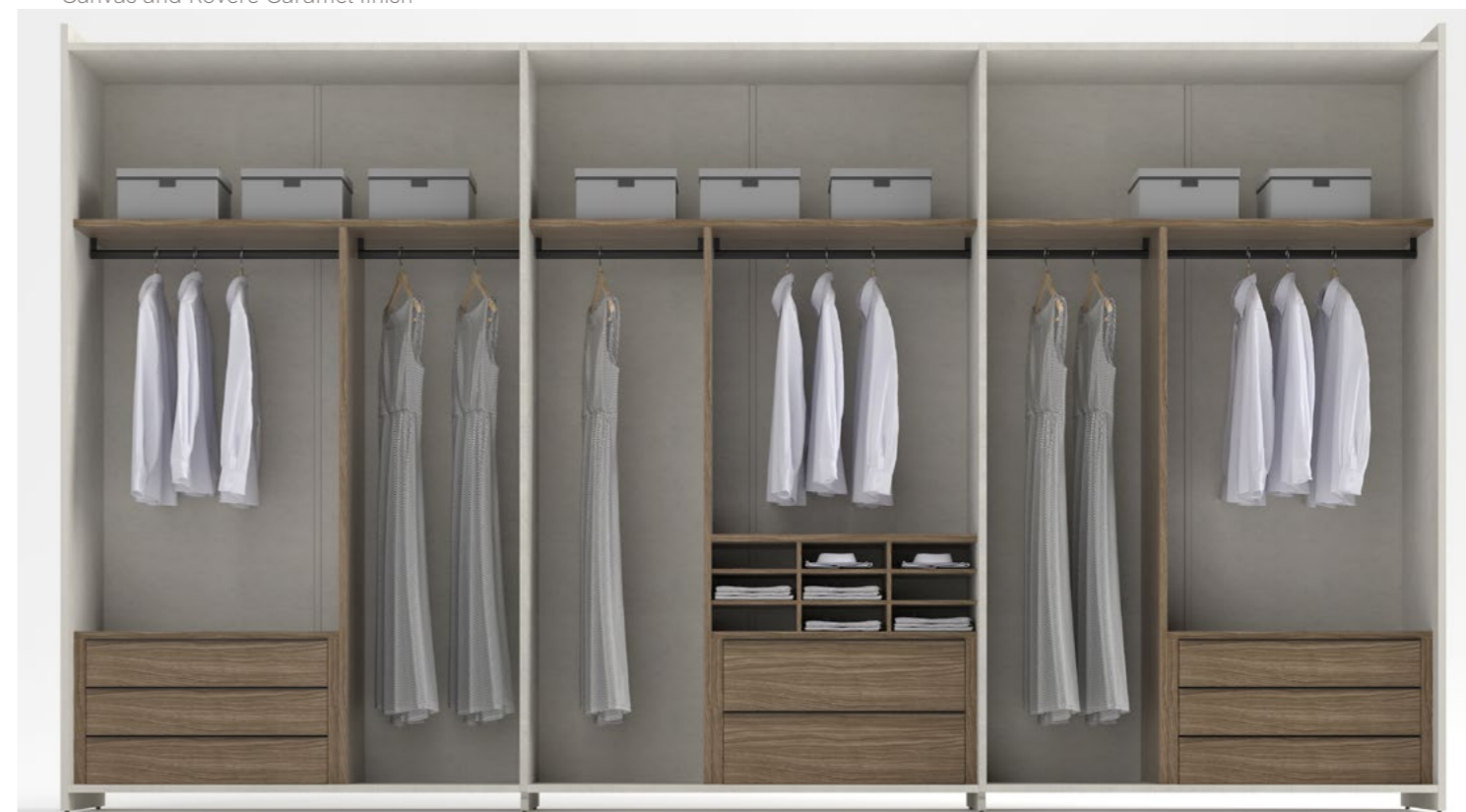

1500

1500

1500

## Appenderie Hangers

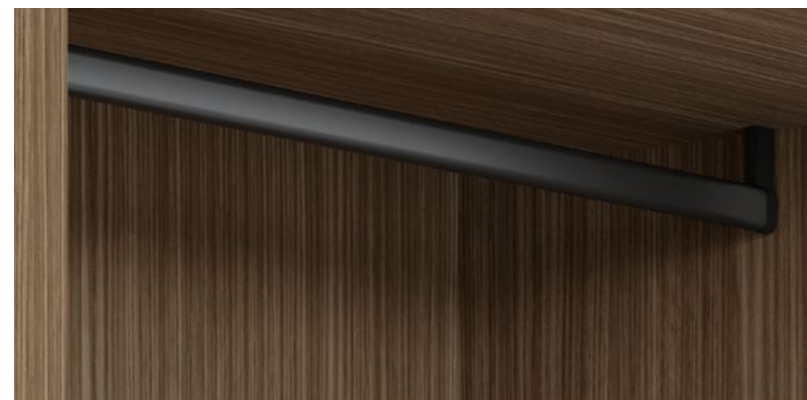

**Tubo appendiabiti**  
Clothes hanging rail

Gli accessori per appendere comprendono sia il tubo appendiabiti che il servetto estraibile, il quale permette di sfruttare anche i vani più alti senza fatica.

The hanging accessories include both the clothes hanging rail and the pull-out Servetto, which allows you to use even the tallest compartments effortlessly.

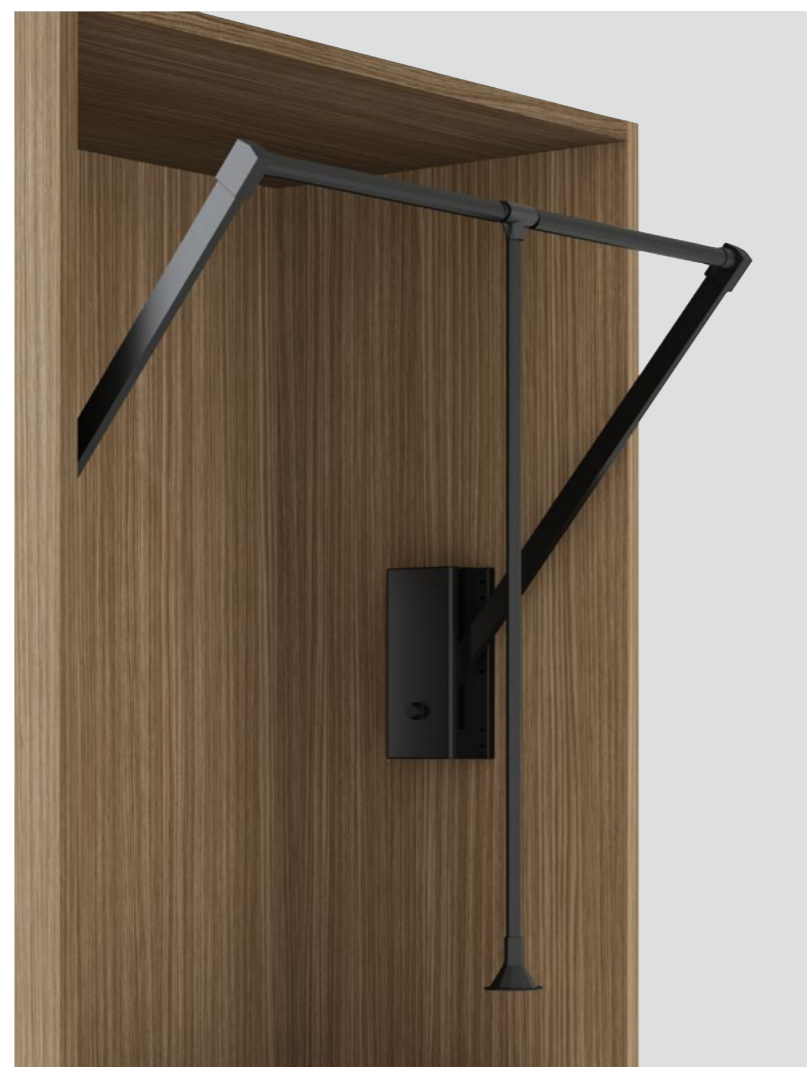

**Servetto estraibile**  
Pull-out Servetto

## Sistema di illuminazione Lighting system



**Lampade laterale da fianco**  
Lateral side lamp

Per un utilizzo confortevole in tutti i momenti del giorno, negli armadi del sistema Atelier è disponibile un'illuminazione Led integrata nei fianchi in verticale.

For comfortable use at all times of the day, the wardrobes in the Atelier system feature LED lighting integrated vertically into the sides.

## Sanificatore d'aria Air sanitizer



Applicato alla schiena dell'armadio, il sanificatore aiuta a purificare gli indumenti e gli accessori dalle particelle inquinanti provenienti dal mondo esterno.

Applied to the back of the wardrobe, the sanitizer helps purify clothing and accessories from polluting particles from the outside world.

## Tipologie ripiani

### Shelves types



**Ripiano di battuta**  
Stop shelf



**Ripiano interno spessore mm 38**  
Internal shelf 38 mm thick

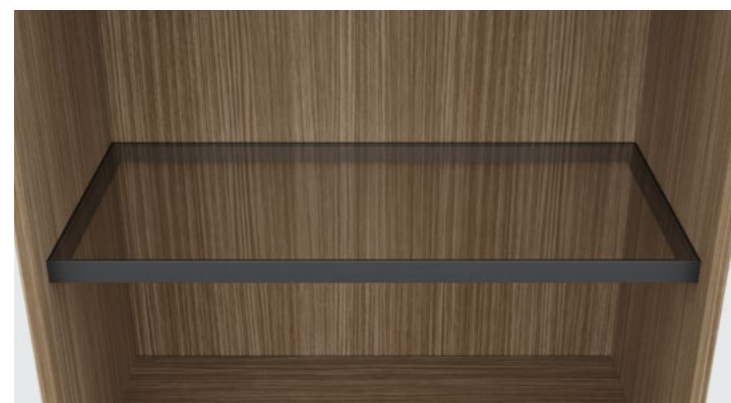

**Ripiano in vetro**  
Glass shelf



**Ripiano interno spessore mm 25**  
Internal shelf 25 mm thick

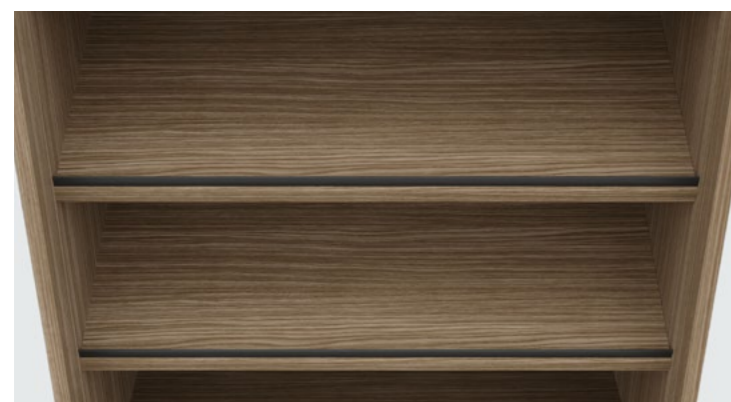

**Ripiano inclinato portascarpe**  
Inclined shoe shelves

## Tipologie cassetti e divisori

### Types of drawers and partitions

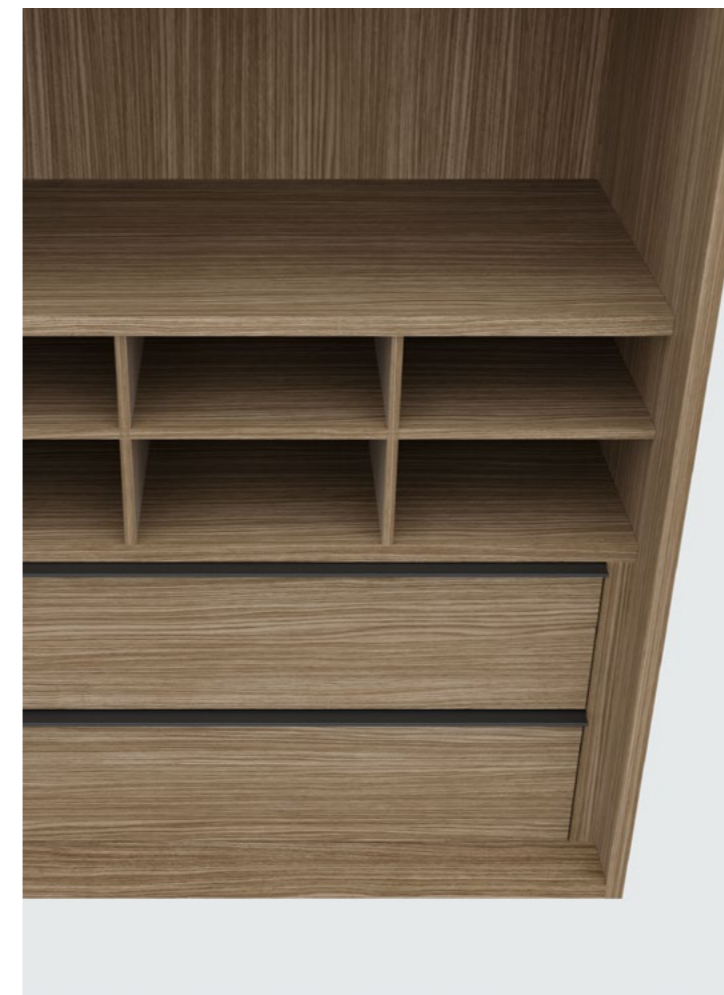

**Cassettiera 2 cassetti e alveare**  
Chest of drawers with 2 drawers and a pigeonhole



**Cassettiera 4 cassetti e divisorio verticale**  
Chest of drawers with 4 drawers and vertical partition

## Elementi estraibili

### Pull-out elements



**Ripiano estraibile**  
Pull-out shelf



**Vassoio estraibile**  
Pull-out tray



**Vassoio estraibile in metallo**  
Metal pull-out tray



**Vassoio portacinture/portacravatte**  
Belt/tie tray



**Telai portapantaloni**  
Trousers rack

## Cesti estraibili

### Pull-out baskets



**Cesto estraibile in metallo h 8 mm**  
Pull-out metal basket h 8 mm



**Cesto estraibile in metallo h 13 mm**  
Pull-out metal basket h 13 mm



**Cesto estraibile in tessuto h 205 mm**  
Pull-out fabric basket h 205 mm



**Cesto estraibile in tessuto h 275 mm**  
Pull-out fabric basket h 275 mm

## Anta Row

Anta dal design lineare e pulito e maniglia a tutta altezza.

Door with a linear and clean design and full-height handle.

### Versioni / Versions

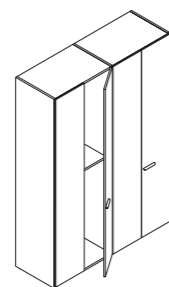

Battente  
Hinged

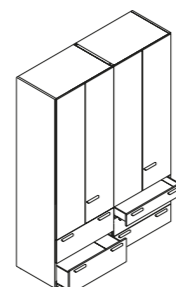

Battente + cassetti  
Hinged + drawers

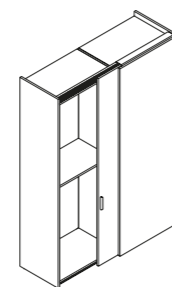

Scorrevole  
Sliding



### Dimensioni anta Battente

Hinged door dimensions

#### Altezze / Heights

2895  
2575  
2415  
2255

#### Larghezze / Widths

anta singola - single door  
425  
475  
575  
doppia anta - double door  
425 + 425  
475 + 475  
575 + 575

### Dimensioni anta Scorrevole

Sliding door dimensions

#### Altezze / Heights

2895  
2575  
2415  
2255

#### Larghezze / Widths

875  
975  
1175

### Maniglia

- profilo estruso in alluminio
- disponibile in tutti i colori laccati
- maniglia a tutta altezza per una presa facilitata
- disponibile per ante battenti, ante scorrevoli e cassetti
- nessun segno di fissaggio o vite a vista

### Handle

- extruded aluminum profile
- available in all lacquered colors
- full height handle for easy grip
- available for hinged doors, sliding doors and drawers
- no signs of fixing or visible screws



### Nobilitati

Melamines

Bianco	Tortora	Titanio
Fango	Stromboli	Alaska
Frassino Normandie	Rovere Caramel	Noce Louisiana
Testa di moro	Cemento	Calce
Canvas		

Vetro  
Glass

Liscio* Smooth
Cannettato* Ribbed

Specchio  
Mirror

Argentato Silver
Fumé Smoked
Bronzo Bronze

### Colori laccature legno / vetro lucido

Wood lacquer colors / glossy glass

Bianco	Ghiaccio	Titanio
Cenere	Selva	Stromboli
Tortora	Canapa	Argilla
Fango	Brandy	Fondente
Salvia	Edera	Tirreno
Baltico	Ametista	Granata

Colori laccature Metal  
Metal lacquer colors

Ghisa Metal	Platino Metal
-------------	---------------

\* Disponibili laccati nelle finiture riportate a lato, esclusi i colori laccature Metal  
Available lacquered in the finishes shown on the side, excluding Metal lacquer colors

## Anta Joint

Anta dal design lineare e pulito. La maniglia, con profilo sottile, spezza la linearità della composizione, mantenendo però una certa rigosità visiva.

Door with a linear and clean design. The handle, with a slim profile, breaks the linearity of the composition, while maintaining a certain visual rigor.

### Versioni / Versions

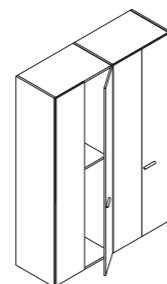

Battente  
Hinged



### Dimensioni anta Battente

Hinged door dimensions

#### Altezze / Heights

2895  
2575  
2415  
2255

#### Larghezze / Widths

anta singola - single door  
425  
475  
575  
doppia anta - double door  
425 + 425  
475 + 475  
575 + 575

### Maniglia

- profilo estruso in alluminio
- disponibile in tutti i colori laccati
- chiusura con tappo in tinta
- presa facilitata
- disponibile per ante battenti
- nessun segno di fissaggio o vite a vista

### Handle

- extruded aluminum profile
- available in all lacquered colors
- closure with matching cap
- easy grip
- available for hinged doors
- no signs of fixing or visible screws



### Nobilitati

#### Melamines

Bianco	Tortora	Titanio
Fango	Stromboli	Alaska
Frassino Normandie	Rovere Caramel	Noce Louisiana
Testa di moro	Cemento	Calce
Canvas		

### Colori laccature

#### Lacquer colors

Bianco	Ghiaccio	Titanio
Cenere	Selva	Stromboli
Tortora	Canapa	Argilla
Fango	Brandy	Fondente
Salvia	Edera	Tirreno
Baltico	Ametista	Granata

### Colori laccature Metal

#### Metal lacquer colors

Ghisa Metal	Platino Metal
-------------	---------------

## Anta Fit

Anta in vetro laccato dal forte impatto visivo. La maniglia dalla forma arrotondata è a incasso per una presa facilitata.

Door in lacquered glass with a strong visual impact. The rounded handle is recessed for an easy grip.

### Versioni / Versions

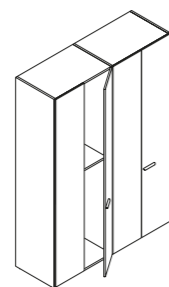

Battente  
Hinged

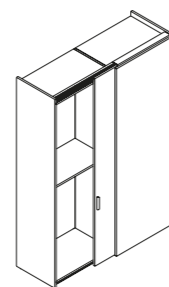

Scorrevole  
Sliding

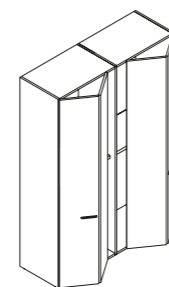

Pieghevole  
Folding



### Dimensioni anta Battente Hinged door dimensions

**Altezze / Heights**  
2895  
2575  
2415  
2255

**Larghezze / Widths**  
anta singola - single door  
425  
475  
575  
doppia anta - double door  
425 + 425  
475 + 475  
575 + 575

### Dimensioni anta Scorrevole Sliding door dimensions

**Altezze / Heights**  
2895  
2575  
2415  
2255

**Larghezze / Widths**  
875  
975  
1175

### Maniglia

- maniglia ad incasso con lavorazione su vetro
- disponibile in tutti i colori laccati, sia con effetto in tinta che a contrasto
- disponibile per ante battenti, ante scorrevoli e ante pieghevoli
- tutti i punti di ancoraggio sono nascosti

### Handle

- recessed handle with glass processing
- available in all lacquered colors, both with matching and contrasting effects
- available for hinged doors, sliding doors and folding doors
- all anchor points are hidden



### Specchio Mirror

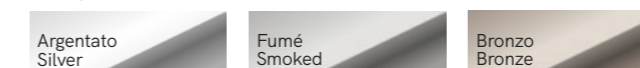

### Colori laccature vetro lucido Glossy glass lacquer colors



### Colori laccature Metal solo interno maniglia Metal lacquer colors only inside the handle



## Anta Double

Anta in doppia finitura: la divisione orizzontale permette l'abbinamento di finiture a contrasto o in tinta, per un effetto di grande raffinatezza.

Door in double finish: the horizontal division allows the combination of contrasting or matching finishes, for a highly refined effect.

### Versioni / Versions

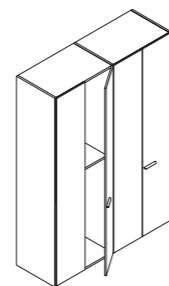

Battente  
Hinged

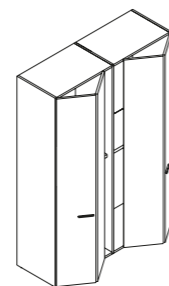

Pieghevole  
Folding



### Dimensioni anta Battente Hinged door dimensions

**Altezze / Heights**  
2575  
2415  
2255

**Larghezze / Widths**  
anta singola - single door  
425  
475  
575  
doppia anta - double door  
425 + 425  
475 + 475  
575 + 575

### Maniglia

- profilo in metallo lavorato
- disponibile in tutti i colori laccati, sia in tinta che a contrasto
- presa facilitata
- disponibile per ante battenti e ante pieghevoli
- spessore sottile

### Handle

- profile in worked metal
- available in all lacquered colors, both matching and contrasting
- easy grip
- available for hinged doors and folding doors
- thin thickness



### Nobilitati Melamines

Bianco	Tortora	Titanio
Fango	Stromboli	Alaska
Frassino Normandie	Rovere Caramel	Noce Louisiana
Testa di moro	Cemento	Calce
Canvas		

### Colori laccature Lacquer colors

Bianco	Ghiaccio	Titanio
Cenere	Selva	Stromboli
Tortora	Canapa	Argilla
Fango	Brandy	Fondente
Salvia	Edera	Tirreno
Baltico	Ametista	Granata

### Colori laccature Metal Metal lacquer colors

Ghisa Metal	Platino Metal
-------------	---------------

## Anta Return

Anta dal design lineare e pulito e maniglia a tutta altezza.

Door with a linear and clean design and full-height handle.

### Versioni / Versions

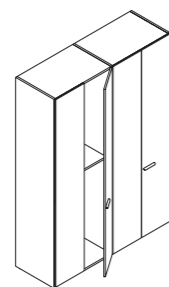

Battente  
Hinged

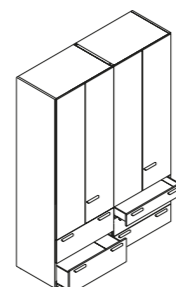

Battente + cassetti  
Hinged + drawers

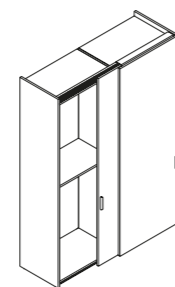

Scorrevole  
Sliding



### Dimensioni anta Battente Hinged door dimensions

#### Altezze / Heights

2895  
2575  
2415  
2255

#### Larghezze / Widths

anta singola - single door  
425  
475  
575  
doppia anta - double door  
425 + 425  
475 + 475  
575 + 575

### Dimensioni anta Scorrevole Sliding door dimensions

Sliding door dimensions

#### Altezze / Heights

2895  
2575  
2415  
2255

#### Larghezze / Widths

875  
975  
1175

### Maniglia

- profilo estruso in alluminio
- maniglia a tutta altezza per una presa facilitata
- disponibile in tutti i colori laccati
- disponibile per ante battenti, ante scorrevoli e cassetti
- nessun segno di fissaggio o vite a vista

### Handle

- extruded aluminum profile
- full height handle for easy grip
- available in all lacquered colors
- available for hinged doors, sliding doors and drawers
- no signs of fixing or visible screws



### Nobilitati

Melamines

Bianco	Tortora	Titanio
Fango	Stromboli	Alaska
Frassino Normandie	Rovere Caramel	Noce Louisiana
Testa di moro	Cemento	Calce
Canvas		

### Colori laccature

Lacquer colors

Bianco	Ghiaccio	Titanio
Cenere	Selva	Stromboli
Tortora	Canapa	Argilla
Fango	Brandy	Fondente
Salvia	Edera	Tirreno
Baltico	Ametista	Granata

### Colori laccature Metal

Metal lacquer colors

Ghisa Metal	Platino Metal
-------------	---------------

## Anta Soft

Anta battente dal disegno geometrico realizzata in pannelli rivestiti in ecopelle imbottita. La maniglia è applicata a tutta altezza.

Hinged door with a geometric design made of panels covered in padded eco-leather. The handle is applied to the full height.

### Versioni / Versions

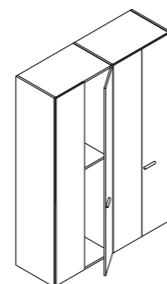

Battente  
Hinged



### Dimensioni anta Battente

Hinged door dimensions

#### Altezze / Heights

2415  
2575  
2255  
2895

#### Larghezze / Widths

anta singola - single door  
425  
475  
575  
doppia anta - double door  
425 + 425  
475 + 475  
575 + 575

### Maniglia

- profilo estruso in alluminio o laccato
- disponibile in tutti i colori laccati
- maniglia a tutta altezza per una presa facilitata
- disponibile in tutti colori laccati
- disponibile per ante battenti

### Handle

- extruded aluminum or lacquered profile
- available in all lacquered colors
- full height handle for easy grip
- available in all lacquered colors
- available for hinged doors



### Ecopelli

Eco leathers

Barbara BC01	Barbara BC02	Barbara BC03
Barbara BC04	Barbara BC05	Barbara BC06
Barbara BC07	Barbara BC08	Barbara BC09
Barbara BC10	Barbara BC11	

### Colori laccature per maniglia

Lacquering colors for handle

Bianco	Ghiaccio	Titanio
Cenere	Selva	Stromboli
Tortora	Canapa	Argilla
Fango	Brandy	Fondente
Salvia	Edera	Tirreno
Baltico	Ametista	Granata

### Colori laccature Metal per maniglia

Metal lacquer colors for handle

Ghisa Metal	Platino Metal
-------------	---------------

## Anta Low

Anta dal design lineare e pulito e maniglia applicata.

Door with a linear and clean design and applied handle.

### Versioni / Versions

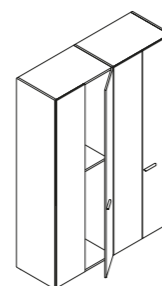

Battente  
Hinged

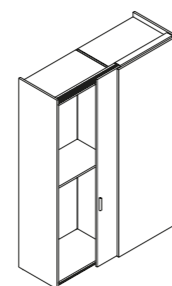

Scorrevole  
Sliding



### Dimensioni anta Battente

Hinged door dimensions

#### Altezze / Heights

2895  
2575  
2415  
2255

#### Larghezze / Widths

anta singola - single door  
425  
475  
575  
doppia anta - double door  
425 + 425  
475 + 475  
575 + 575

### Dimensioni anta Scorrevole

Sliding door dimensions

#### Altezze / Heights

2895  
2575  
2415  
2255

#### Larghezze / Widths

875  
975  
1175

### Maniglia

- profilo estruso in alluminio
- disponibile in tutti i colori laccati
- presa facilitata grazie al dente
- disponibile per ante battenti e ante scorrevoli
- nessun segno di fissaggio o vite a vista

### Handle

- extruded aluminum profile
- available in all lacquered colors
- easy grip thanks to the tooth
- available for hinged doors and sliding doors
- no signs of fixing or visible screws



### Nobilitati

Melamines

Bianco	Tortora	Titanio
Fango	Stromboli	Alaska
Frassino Normandie	Rovere Caramel	Noce Louisiana
Testa di moro	Cemento	Calce
Canvas		

### Colori laccature

Lacquer colors

Bianco	Ghiaccio	Titanio
Cenere	Selva	Stromboli
Tortora	Canapa	Argilla
Fango	Brandy	Fondente
Salvia	Edera	Tirreno
Baltico	Ametista	Granata

### Colori laccature Metal

Metal lacquer colors

Ghisa Metal	Platino Metal
-------------	---------------

## Anta Line maniglia Ego

Anta dal design lineare e pulito  
e maniglia applicata Ego.

Door with a linear and clean  
design and Ego applied handle.

### Versioni / Versions

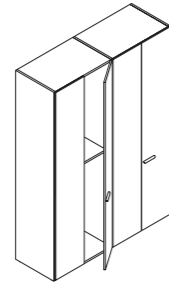

Battente  
Hinged

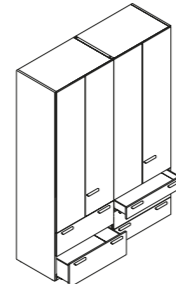

Battente + cassetti  
Hinged + drawers

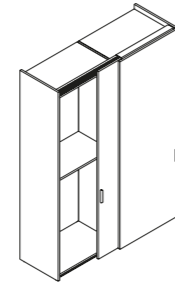

Scorrevole  
Sliding

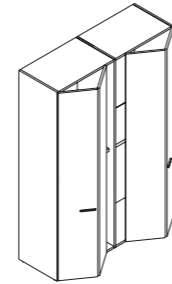

Pieghevole  
Folding



### Dimensioni anta Battente Hinged door dimensions

**Altezze / Heights**  
2895  
2575  
2415  
2255

**Larghezze / Widths**  
anta singola - single door  
425  
475  
575  
doppia anta - double door  
425 + 425  
475 + 475  
575 + 575

### Dimensioni anta Scorrevole Sliding door dimensions

**Altezze / Heights**  
2895  
2575  
2415  
2255

**Larghezze / Widths**  
875  
975  
1175

### Maniglia Ego

- maniglia in metallo stampato
- disponibile in colore Ghisa Metal e Platino Metal
- presa facilitata
- disponibile per ante battenti, ante scorrevoli, cassetti e ante pieghevoli

### Varianti

- altre maniglie a incasso o esterne disponibili a listino

### Ego Handle

- handle in pressed metal
- available in Ghisa Metal and Platino Metal color
- easy grip
- available for hinged doors, sliding doors, drawers and folding doors

### Variants

- other recessed or external handles available in the price list



### Nobilitati Melamines

Bianco	Tortora	Titanio
Fango	Stromboli	Alaska
Frassino Normandie	Rovere Caramel	Noce Louisiana
Testa di moro	Cemento	Calce
Canvass		

### Colori laccature Lacquer colors

Bianco	Ghiaccio	Titanio
Cenere	Selva	Stromboli
Tortora	Canapa	Argilla
Fango	Brandy	Fondente
Salvia	Edera	Tirreno
Baltico	Ametista	Granata

### Colori laccature Metal Metal lacquer colors

Ghisa Metal	Platino Metal
-------------	---------------

## Anta Line maniglia Slot

Anta dal design lineare e pulito e maniglia Slot a incasso dall'estetica squadrata.

Door with a linear and clean design and recessed Slot handle with a square aesthetic.

### Versioni / Versions

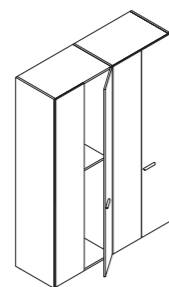

Battente  
Hinged

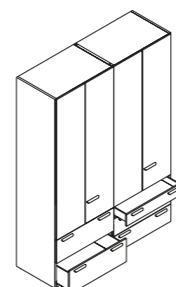

Battente + cassetti  
Hinged + drawers

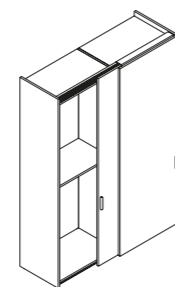

Scorrevole  
Sliding

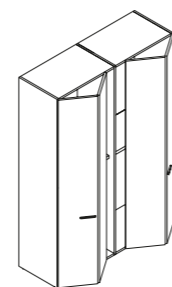

Pieghevole  
Folding



### Dimensioni anta Battente Hinged door dimensions

#### Altezze / Heights

2895  
2575  
2415  
2255

#### Larghezze / Widths

anta singola - single door  
425  
475  
575  
doppia anta - double door  
425 + 425  
475 + 475  
575 + 575

### Dimensioni anta Scorrevole Sliding door dimensions

#### Altezze / Heights

2895  
2575  
2415  
2255

#### Larghezze / Widths

875  
975  
1175

### Maniglia Slot

- maniglia in metallo stampato
- disponibile in colore Ghisa Metal e Platino Metal
- presa facilitata
- disponibile per ante battenti, ante scorrevoli, cassetti e ante pieghevoli
- design squadrato

### Varianti

- altre maniglie a incasso o esterne disponibili a listino

### Slot Handle

- handle in pressed metal
- available in Ghisa Metal and Platino Metal color
- easy grip
- available for hinged doors, sliding doors, drawers and folding doors
- square design

### Variants

- other recessed or external handles available in the price list



### Nobilitati

#### Melamines

Bianco	Tortora	Titanio
Fango	Stromboli	Alaska
Frassino Normandie	Rovere Caramel	Noce Louisiana
Testa di moro	Cemento	Calce
Canvas		

### Colori laccature

#### Lacquer colors

Bianco	Ghiaccio	Titanio
Cenere	Selva	Stromboli
Tortora	Canapa	Argilla
Fango	Brandy	Fondente
Salvia	Edera	Tirreno
Baltico	Ametista	Granata

### Colori laccature Metal

#### Metal lacquer colors

Ghisa Metal	Platino Metal
-------------	---------------

## Anta Line maniglia Duo

Anta dal design lineare e pulito e maniglia applicata Duo dal design distintivo.

Door with a linear and clean design and Duo applied handle with a distinctive design.

### Versioni / Versions

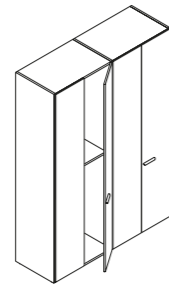

Battente  
Hinged

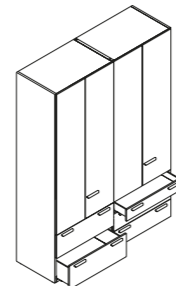

Battente + cassetti  
Hinged + drawers

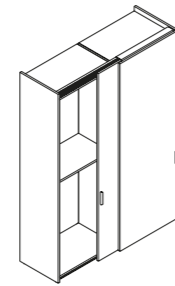

Scorrevole  
Sliding

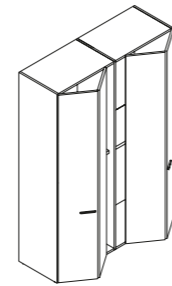

Pieghevole  
Folding



### Dimensioni anta Battente

Hinged door dimensions

#### Altezze / Heights

2895  
2575  
2415  
2255

#### Larghezze / Widths

anta singola - single door  
425  
475  
575  
doppia anta - double door  
425 + 425  
475 + 475  
575 + 575

### Dimensioni anta Scorrevole

Sliding door dimensions

#### Altezze / Heights

2895  
2575  
2415  
2255

#### Larghezze / Widths

875  
975  
1175

### Maniglia Duo

- maniglia in metallo stampato
- disponibile in colore Ghisa Metal e Platino Metal
- presa facilitata
- disponibile per ante battenti, ante scorrevoli cassetti e ante pieghevoli

### Varianti

- altre maniglie a incasso o esterne disponibili a listino

### Duo Handle

- handle in pressed metal
- available in Ghisa Metal and Platino Metal color
- easy grip
- available for hinged doors, sliding doors, drawers and folding doors

### Variants

- other recessed or external handles available in the price list



### Nobilitati

Melamines

Bianco	Tortora	Titanio
Fango	Stromboli	Alaska
Frassino Normandie	Rovere Caramel	Noce Louisiana
Testa di moro	Cemento	Calce
Canvas		

### Vetro

Glass

Liscio* Smooth	Argentato Silver
Cannettato* Ribbed	Fumé Smoked
	Bronzo Bronze

### Specchio

Mirror

### Colori laccature legno / vetro lucido

Wood lacquer colors / glossy glass

Bianco	Ghiaccio	Titanio
Cenere	Selva	Stromboli
Tortora	Canapa	Argilla
Fango	Brandy	Fondente
Salvia	Edera	Tirreno
Baltico	Ametista	Granata

### Colori laccature Metal

Metal lacquer colors

Ghisa Metal	Platino Metal
-------------	---------------

\* Disponibili laccati nelle finiture riportate a lato, esclusi i colori laccature Metal  
Available lacquered in the finishes shown on the side, excluding Metal lacquer colors

## Anta Line maniglia Trapezio

Anta dal design lineare e  
maniglia Trapezio applicata.

Door with a linear design  
and Trapezio handle applied.

### Versioni / Versions

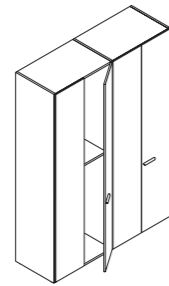

Battente  
Hinged

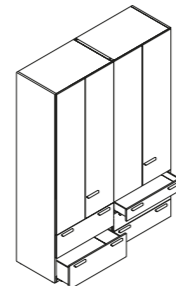

Battente + cassetti  
Hinged + drawers

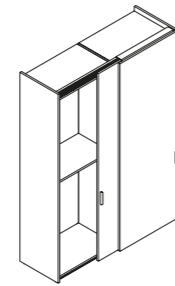

Scorrevole  
Sliding

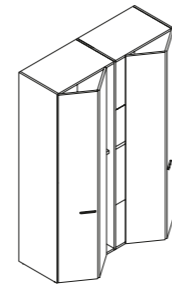

Pieghevole  
Folding



### Dimensioni anta Battente Hinged door dimensions

**Altezze / Heights**  
2895  
2575  
2415  
2255

**Larghezze / Widths**  
anta singola - single door  
425  
475  
575  
doppia anta - double door  
425 + 425  
475 + 475  
575 + 575

### Dimensioni anta Scorrevole Sliding door dimensions

**Altezze / Heights**  
2895  
2575  
2415  
2255

**Larghezze / Widths**  
875  
975  
1175

### Maniglia Trapezio

- profilo in alluminio estruso e lavorato
- disponibile in colore Ghisa Metal
- disponibile per ante battenti, ante scorrevoli, cassetti e ante pieghevoli

### Varianti

- altre maniglie a incasso o esterne disponibili a listino

### Trapezio Handle

- extruded and worked aluminum profile
- available in Ghisa Metal color
- available for hinged doors, sliding doors, drawers and folding doors

### Variants

- other recessed or external handles available in the price list



### Nobilitati Melamines

Bianco	Tortora	Titanio
Fango	Stromboli	Alaska
Frassino Normandie	Rovere Caramel	Noce Louisiana
Testa di moro	Cemento	Calce
Canvas		

### Colori laccature Lacquer colors

Bianco	Ghiaccio	Titanio
Cenere	Selva	Stromboli
Tortora	Canapa	Argilla
Fango	Brandy	Fondente
Salvia	Edera	Tirreno
Baltico	Ametista	Granata

### Colori laccature Metal Metal lacquer colors

Ghisa Metal	Platino Metal
-------------	---------------

## Anta Ruler

Anta dal design lineare e pulito e maniglia a tutta altezza.

Door with a linear and clean design and full-height handle.

### Versioni / Versions

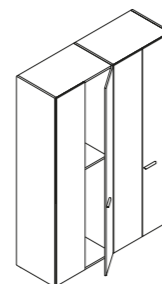

Battente  
Hinged

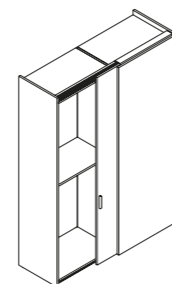

Scorrevole  
Sliding



### Dimensioni anta Battente Hinged door dimensions

#### Altezze / Heights

2895  
2575  
2415  
2255

#### Larghezze / Widths

anta singola - single door  
425  
475  
575  
doppia anta - double door  
425 + 425  
475 + 475  
575 + 575

### Dimensioni anta Scorrevole Sliding door dimensions

#### Altezze / Heights

2895  
2575  
2415  
2255

#### Larghezze / Widths

875  
975  
1175

### Maniglia

- profilo estruso in alluminio
- disponibile in tutti i colori laccati
- presa facilitata grazie all'inclinazione della maniglia
- disponibile per ante battenti e ante scorrevoli
- nessun segno di fissaggio o vite a vista

### Handle

- extruded aluminum profile
- available in all lacquered colors
- easy grip thanks to the inclination of the handle
- available for hinged doors and sliding doors
- no signs of fixing or visible screws



### Nobilitati

#### Melamines

Bianco	Tortora	Titanio
Fango	Stromboli	Alaska
Frassino Normandie	Rovere Caramel	Noce Louisiana
Testa di moro	Cemento	Calce
Canvas		

### Colori laccature

#### Lacquer colors

Bianco	Ghiaccio	Titanio
Cenere	Selva	Stromboli
Tortora	Canapa	Argilla
Fango	Brandy	Fondente
Salvia	Edera	Tirreno
Baltico	Ametista	Granata

### Colori laccature Metal

#### Metal lacquer colors

Ghisa Metal	Platino Metal
-------------	---------------

## Anta Crystal

Anta battente con profilo in alluminio e ante in vetro intelaiato con cerniere pivottanti, installabili su fianchi in vetro o legno. La maniglia è a incasso.

Hinged door with aluminum profile and framed glass doors with pivoting hinges, which can be installed on glass or wooden sides. The handle is recessed.

### Versioni / Versions

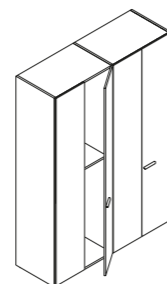

Battente  
Hinged



### Dimensioni anta Battente

Hinged door dimensions

**Altezze / Heights**  
2575  
2255

**Larghezze / Widths**  
anta singola - single door  
475  
doppia anta - double door  
475 + 475

### Maniglia

- maniglia a incasso
- disponibile in colore Ghisa Metal
- presa facilitata
- disponibile per ante battenti

### Handle

- recessed handle
- available in Ghisa Metal color
- easy grip
- available for hinged doors



### Vetro

Glass

Trasparente  
Transparent

Fumé  
Smoked

Bronzo  
Bronze

Cannettato trasparente  
Transparent ribbed

### Vetro acidato

Etched glass

Trasparente  
Transparent

Fumé  
Smoked

Bronzo  
Bronze

### Colori laccature Metal per profilo

Metal lacquer colors for profile

Ghisa Metal

## Anta Ritmo

Anta scorrevole con stacco centrale che, abbinato alla maniglia in tinta o a contrasto, crea un effetto di dinamismo.

Sliding door with central detachment which, combined with the matching or contrasting handle, creates a dynamic effect.

### Versioni / Versions

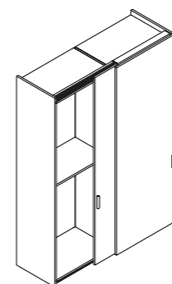

Scorrevole  
Sliding



### Dimensioni anta Scorrevole Sliding door dimensions

#### Altezze / Heights

2895  
2575  
2415  
2255

#### Larghezze / Widths

875  
975  
1175

### Maniglia

- profilo estruso in alluminio
- disponibile in tutti i colori laccati
- presa facilitata
- disponibile per ante scorrevoli
- nessun segno di fissaggio o vite a vista

### Handle

- extruded aluminum profile
- available in all lacquered colors
- easy grip
- available for sliding doors
- no signs of fixing or visible screws



### Nobilitati Melamines

Bianco	Tortora	Titanio
Fango	Stromboli	Alaska
Frassino Normandie	Rovere Caramel	Noce Louisiana
Testa di moro	Cemento	Calce
Canvas		

### Colori laccature Lacquer colors

Bianco	Ghiaccio	Titanio
Cenere	Selva	Stromboli
Tortora	Canapa	Argilla
Fango	Brandy	Fondente
Salvia	Edera	Tirreno
Baltico	Ametista	Granata

### Colori laccature Metal Metal lacquer colors

Ghisa Metal	Platino Metal
-------------	---------------

## Anta Shine

Anta scorrevole con fascia centrale che può essere in tinta o a contrasto, in pannello di legno o vetro, per creare un interessante effetto visivo.

Sliding door with central band that can be in the same color or in contrast, in wood or glass panel, to create an interesting visual effect.

### Versioni / Versions

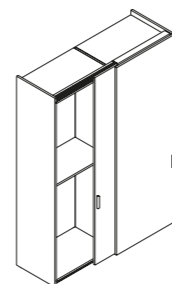

Scorrevole  
Sliding



### Dimensioni anta Scorrevole

Sliding door dimensions

#### Altezze / Heights

2895  
2575  
2415  
2255

#### Larghezze / Widths

875  
975  
1175

### Maniglia

- profilo sagomato in metallo
- disponibile in tutti i colori laccati
- presa facilitata
- disponibile per ante scorrevoli

### Handle

- shaped profile in metal
- available in all lacquered colors
- easy grip
- available for sliding doors



### Nobilitati

Melamines

Bianco	Tortora	Titanio
Fango	Stromboli	Alaska
Frassino Normandie	Rovere Caramel	Noce Louisiana
Testa di moro	Cemento	Calce
Canvass		

### Vetro

Glass

Liscio*	Argentato
Smooth	Silver
Cannettato*	Fumé
Ribbed	Smoked
	Bronzo
	Bronze

### Specchio

Mirror

Argentato
Silver
Fumé
Smoked
Bronzo
Bronze

### Colori laccature legno / vetro lucido

Wood lacquer colors / glossy glass

Bianco	Ghiaccio	Titanio
Cenere	Selva	Stromboli
Tortora	Canapa	Argilla
Fango	Brandy	Fondente
Salvia	Edera	Tirreno
Baltico	Ametista	Granata

### Colori laccature Metal

Metal lacquer colors

Ghisa Metal	Platino Metal
-------------	---------------

\* Disponibili laccati nelle finiture riportate a lato, esclusi i colori laccature Metal  
Available lacquered in the finishes shown on the side, excluding Metal lacquer colors

## Anta Mondrian

Anta scorrevole con disegni a fasce orizzontali e verticali, combinabili tra loro, anche abbinando pannelli in legno e vetro. La maniglia è a tutta altezza.

Sliding door with designs in horizontal and vertical bands, which can be combined with each other, also combining wood and glass panels. The handle is full height.

### Versioni / Versions

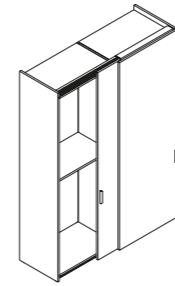

Scorrevole  
Sliding

### Disegno ante Door design



### Dimensioni anta Scorrevole Sliding door dimensions

**Altezze / Heights**  
2895  
2575  
2415  
2255

**Larghezze / Widths**  
875  
975  
1175  
1475

### Maniglia

- profilo estruso in alluminio
- disponibile in tutti i colori laccati
- maniglia a tutta altezza per una presa facilitata
- disponibile per ante scorrevoli
- nessun segno di fissaggio o vite a vista

### Handle

- extruded aluminum profile
- available in all lacquered colors
- full height handle for easy grip
- available for sliding doors
- no signs of fixing or visible screws



### Nobilitati Melamines

Bianco	Tortora	Titanio
Fango	Stromboli	Alaska
Frassino Normandie	Rovere Caramel	Noce Louisiana
Testa di moro	Cemento	Calce
Canvass		

### Vetro Glass

Liscio* Smooth	Argentato Silver
Cannettato* Ribbed	Fumé Smoked
	Bronzo Bronze

### Specchio Mirror

### Colori laccature legno / vetro lucido Wood lacquer colors / glossy glass

Bianco	Ghiaccio	Titanio
Cenere	Selva	Stromboli
Tortora	Canapa	Argilla
Fango	Brandy	Fondente
Salvia	Edera	Tirreno
Baltico	Ametista	Granata

### Colori laccature Metal Metal lacquer colors

Ghisa Metal	Platino Metal
-------------	---------------

\* Disponibili laccati nelle finiture riportate a lato, esclusi i colori laccature Metal  
Available lacquered in the finishes shown on the side, excluding Metal lacquer colors

## Anta Square

Anta scorrevole con disegno a quadri e maniglia a tutta altezza. Possibilità di affiancare pannelli in legno e vetro in due diverse colonne, per creare interessanti giochi visivi.

Sliding door with checked design and full-height handle. Possibility of placing wood and glass panels side by side in two different columns, to create interesting visual effects.

### Versioni / Versions

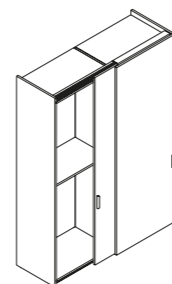

Scorrevole  
Sliding



### Dimensioni anta Scorrevole Sliding door dimensions

#### Altezze / Heights

2895  
2575  
2415  
2255

#### Larghezze / Widths

875  
975  
1175

### Maniglia

- profilo estruso in alluminio
- raddrizza anta incorporato
- disponibile in colore Ghisa Metal
- maniglia a tutta altezza per una presa facilitata
- disponibile per ante scorrevoli

### Handle

- extruded aluminum profile
- incorporated door straightener
- available in Ghisa Metal color
- full height handle for easy grip
- available for sliding doors



### Nobilitati

#### Melamines

Bianco	Tortora	Titanio
Fango	Stromboli	Alaska
Frassino Normandie	Rovere Caramel	Noce Louisiana
Testa di moro	Cemento	Calce
Canvas		

### Specchio

#### Mirror

Argentato Silver	Fumé Smoked	Bronzo Bronze
---------------------	----------------	------------------

### Colori laccature legno / vetro lucido

#### Wood lacquer colors / glossy glass

Bianco	Ghiaccio	Titanio
Cenere	Selva	Stromboli
Tortora	Canapa	Argilla
Fango	Brandy	Fondente
Salvia	Edera	Tirreno
Baltico	Ametista	Granata

### Colori laccature Metal

#### Metal lacquer colors

Ghisa Metal	Platino Metal
-------------	---------------

## Anta Plane

Anta in vetro intelaiato ad apertura scorrevole con profilo in alluminio e montabile su fianchi in legno.

Framed glass door with sliding opening with aluminum profile and mountable on wooden sides.

### Versioni / Versions

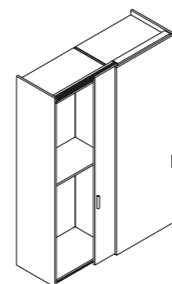

Scorrevole  
Sliding



### Dimensioni anta Scorrevole Sliding door dimensions

#### Altezze / Heights

2895  
2575  
2415  
2255

#### Larghezze / Widths

875  
975  
1175

### Maniglia

- profilo estruso in alluminio
- disponibile in colore Ghisa Metal
- maniglia a tutta altezza per una presa facilitata
- disponibile per ante scorrevoli
- nessun segno di fissaggio o vite a vista

### Handle

- extruded aluminum profile
- available in Ghisa Metal color
- full height handle for easy grip
- available for sliding doors
- no signs of fixing or visible screws



### Vetro Glass

Trasparente\*  
Transparent

Fumé  
Smoked

Bronzo  
Bronze

Cannettato\*  
Reeded

### Vetro acidato Etched glass

Trasparente  
Transparent

Fumé  
Smoked

Bronzo  
Bronze

### Specchio Mirror

Argentato  
Silver

Fumé  
Smoked

Bronzo  
Bronze

### Colori laccature vetro lucido Glossy glass lacquer colors

Bianco

Cenere

Tortora

Fango

Salvia

Baltico

Ghiaccio

Selva

Canapa

Brandy

Edera

Ametista

Titanio

Stromboli

Argilla

Fondente

Tirreno

Granata

### Colori laccature Metal per profilo Metal lacquer colors

Ghisa Metal

\* Disponibili anche laccati nelle finiture riportate a lato, esclusi i colori laccature Metal  
Available lacquered in the finishes shown on the side, excluding Metal lacquer colors

Informazioni tecniche  
Cabine armadio

**Technical information Walk-in wardrobes**

## Up&Down



Up&Down è un sistema per cabine armadio a cremagliera con pannelli a montaggio orizzontale estremamente versatile e dalle finiture che ne esaltano l'eleganza. Le infinite varianti sono possibili grazie anche all'ampia gamma di attrezzature che possono essere installate, come mensole, vassoi, alveari, cassettiere e tubi appendiabiti.

Up&Down is an extremely versatile rack system for walk-in wardrobes with horizontally mounted panels and finishes that enhance its elegance. The infinite variations are possible also thanks to the wide range of equipment that can be installed, such as shelves, trays, pigeonholes, chests of drawers and clothes hanging rails.

## Vertical



Vertical è il sistema minimalista per cabine armadio con montante installabile a parete o a soffitto. La grande varietà di attrezzature installabili permette di personalizzare al massimo lo spazio secondo le proprie abitudini e necessità. Mensole, vassoi, alveari e cassettiere si abbinano e combinano per ospitare indumenti e accessori.

Vertical is the minimalist system for walk-in wardrobes with an upright that can be installed on the wall or ceiling. The large variety of equipment that can be installed allows you to customize the space to the maximum according to your habits and needs. Shelves, trays, pigeonholes and chests of drawers match and combine to house garments and accessories.

UP&amp;DOWN

## Dimensioni Dimensions

Il sistema per cabine armadio a cremagliera Up&Down è disponibile in moduli da sei larghezze e quattro altezze diverse, per la massima adattabilità.

The Up&Down rack system for walk-in wardrobes is available in modules of six widths and four different heights, for maximum adaptability.

### Altezze / Heights

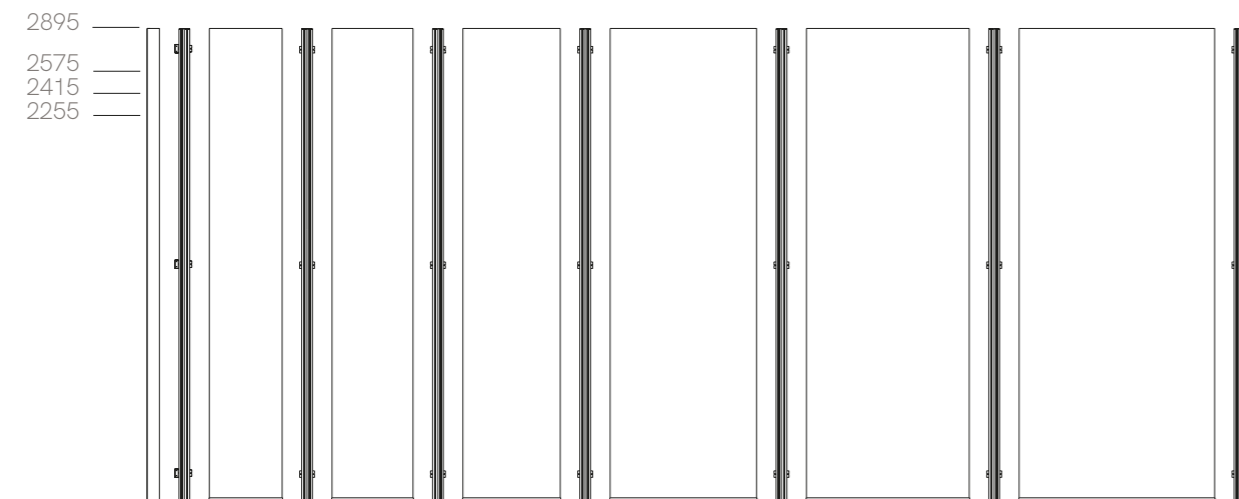

### Larghezze / Widths

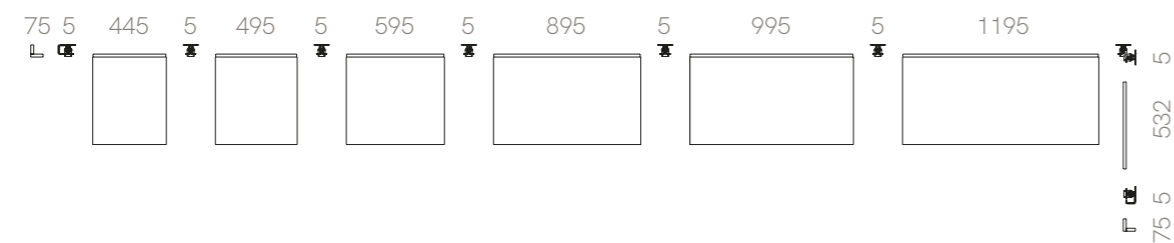

UP&amp;DOWN

## Componenti struttura Structure components

Gli elementi che compongono il sistema Up&Down possono essere combinati per adattarsi alle esigenze di ogni spazio. Oltre ai componenti strutturali, sono disponibili mensole, portapantaloni, alveari, cassettiere, portascarpe e tubi appendiabiti.

The elements that make up the Up&Down system can be combined to adapt to the needs of each space. In addition to the structural components, shelves, trouser racks, pigeonholes, chests of drawers, shoe shelves and clothes hanging rails are available.

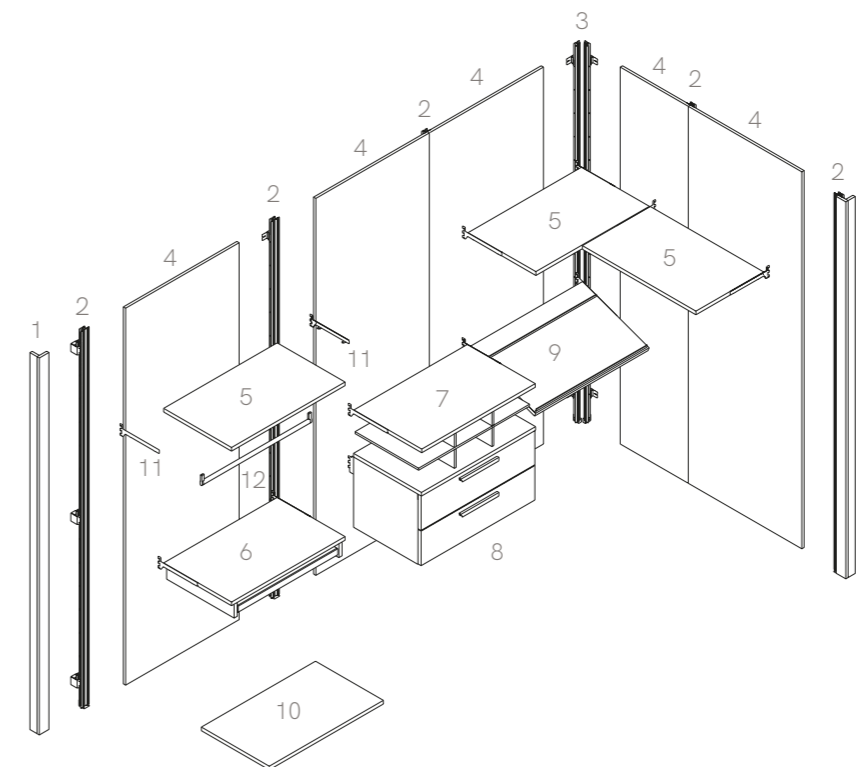

### Pannellatura a muro: elementi strutturali

- 1 Terminale
- 2 Montante centrale
- 3 Struttura per angolo
- 4 Pannello
- 5 Mensola
- 6 Portapantaloni
- 7 Alveare
- 8 Cassetiera
- 9 Mensola Portascarpe
- 10 Base
- 11 Reggimensola
- 12 Tubo Appendiabiti

### Wall paneling: structural elements

- 1 End unit
- 2 Central upright
- 3 Corner structure
- 4 Panel
- 5 Shelf
- 6 Trouser rack
- 7 Pigeonhole
- 8 Chest of drawers
- 9 Shoe shelves
- 10 Base
- 11 Shelf bracket
- 12 Clothes hanging rail

UP&DOWN

Componenti struttura  
Structure components

Tipologie pannelli e terminale

- 1 Terminale
- 2 Pannello Melaminico
- 3 Pannello con Specchio

Panel and end unit types

- 1 End unit
- 2 Melamine panel
- 3 Panel with mirror

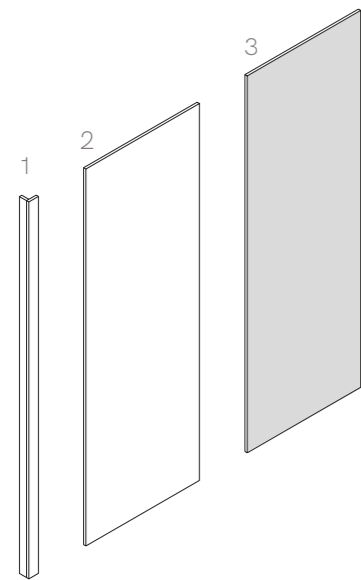

Nobilitati  
Melamines

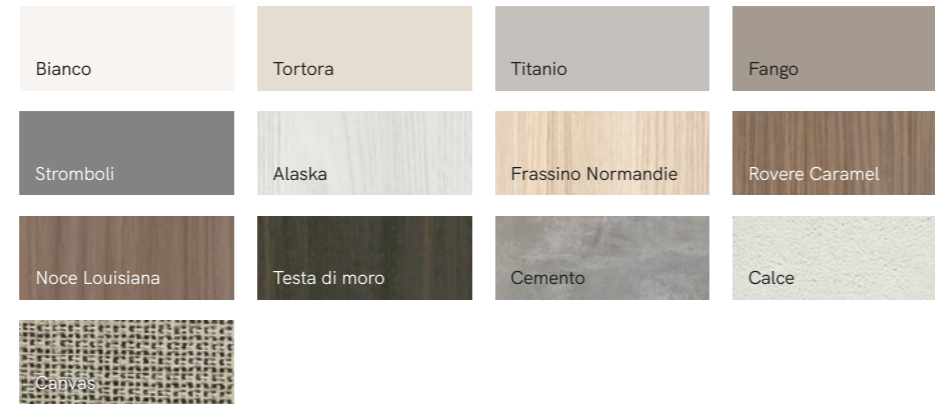

Colori laccature  
Lacquer colors



Colori laccature Metal  
Metal lacquer colors



Specchio  
Mirror

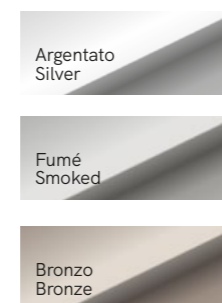

UP&DOWN

Componenti struttura  
Structure components

Tipologie base e mensole

- 1 Base con piedini regolabili
- 2 Mensola con reggimensola
- 3 Mensola portascarpe con reggimensola

Base and shelves types

- 1 Base with adjustable feet
- 2 Shelf with shelf bracket
- 3 Shoe shelves with shelf bracket

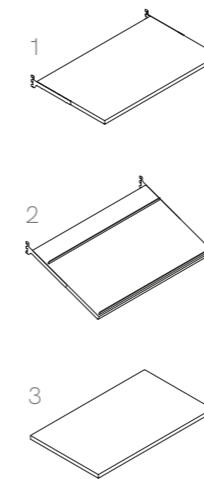

Nobilitati  
Melamines

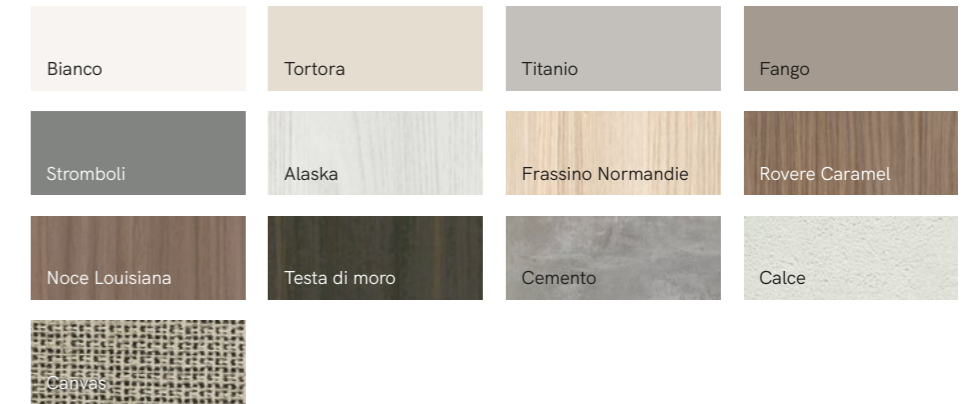

Colori laccature  
Lacquer colors



Colori laccature Metal  
Metal lacquer colors



Tipologie appendiabiti

- 1 Tubo appendiabiti

Clothes hanging rails types

- 1 Clothes hanging rail

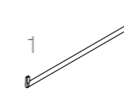

Colori laccature Metal  
Metal lacquer colors

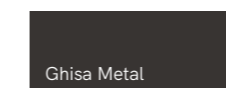

Tipologie strutture interne

- 1 Montante centrale
- 2 Struttura per angolo

Types of internal structures

- 1 Central upright
- 2 Corner structure

Colori laccature Metal  
Metal lacquer colors

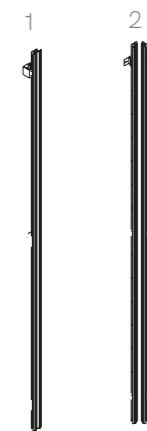
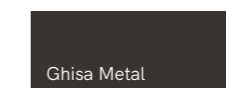

UP&amp;DOWN

## Soluzioni speciali Special solutions

La grande versatilità del sistema Up&Down si esprime anche nella sua adattabilità a situazioni architettoniche particolari: i pannelli possono essere tagliati per soffitti mansardati, oppure essere realizzati a misura, oppure ancora per montaggio in nicchia.

The great versatility of the Up&Down system is also expressed in its adaptability to particular architectural situations: the panels can be cut for attic ceilings, or made to measure, or again for installation in niches.

### Taglio inclinato per mansarda Inclined cut for attic

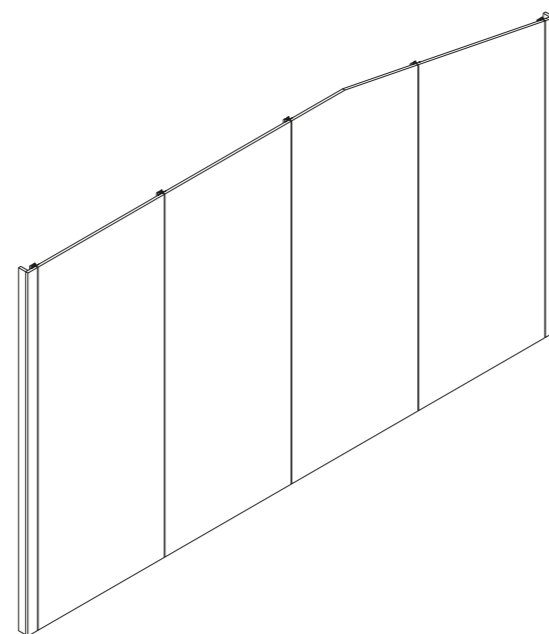

### Pannelli a misura sia centrali che laterali Panels to measure both central and lateral

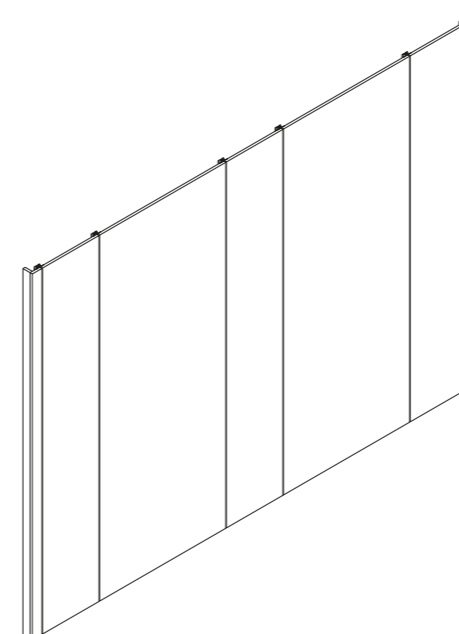

### Montaggio in nicchia Niche installation

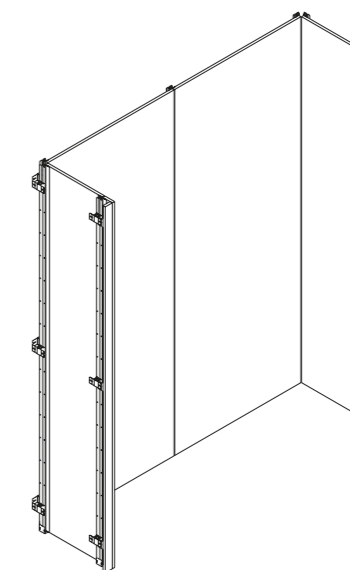

UP&amp;DOWN

## Organizzazione degli interni Interior organization

- |  |  |  |  |  |  |   |   |   |
|--|--|--|--|--|--|---|---|---|
| <b>1</b><br>Mensole<br>Alveare<br>Cassettiera sospesa<br>Base              | <b>2</b><br>Mensole<br>Mensole portascarpe<br>Base | <b>3</b><br>Mensole<br>Alveare<br>Cassettiera sospesa<br>Base              | <b>4</b><br>Mensole<br>Tubo appendiabiti<br>Telaio con sacca<br>Base | <b>5</b><br>Mensole<br>Tubo appendiabiti<br>Alveare<br>Cassettiera sospesa<br>Base               | <b>6</b><br>Mensole<br>Tubo appendiabiti<br>Telai portapantaloni<br>Base | <b>7</b><br>Mensole<br>Tubo appendiabiti<br>Cassettiera<br>in appoggio<br>Base    | <b>8</b><br>Mensole<br>Cassettiera<br>in appoggio<br>Base   | <b>9</b><br>Mensole<br>Cassettiera<br>in appoggio<br>Base   |
| <b>1</b><br>Shelves<br>Pigeonhole<br>Suspended chest<br>of drawers<br>Base | <b>2</b><br>Shelf<br>Shoe shelves<br>Base          | <b>3</b><br>Shelves<br>Pigeonhole<br>Suspended chest<br>of drawers<br>Base | <b>4</b><br>Shelf<br>Clothes hanging rail<br>Frame with bag<br>Base  | <b>5</b><br>Shelf<br>Clothes hanging rail<br>Pigeonhole<br>Suspended chest<br>of drawers<br>Base | <b>6</b><br>Shelf<br>Clothes hanging rail<br>Trousers rack<br>Base       | <b>7</b><br>Shelf<br>Clothes hanging rail<br>Standing chest<br>of drawers<br>Base | <b>8</b><br>Shelves<br>Standing chest<br>of drawers<br>Base | <b>9</b><br>Shelves<br>Standing chest<br>of drawers<br>Base |



UP&DOWN  
Attrezzature  
Equipment

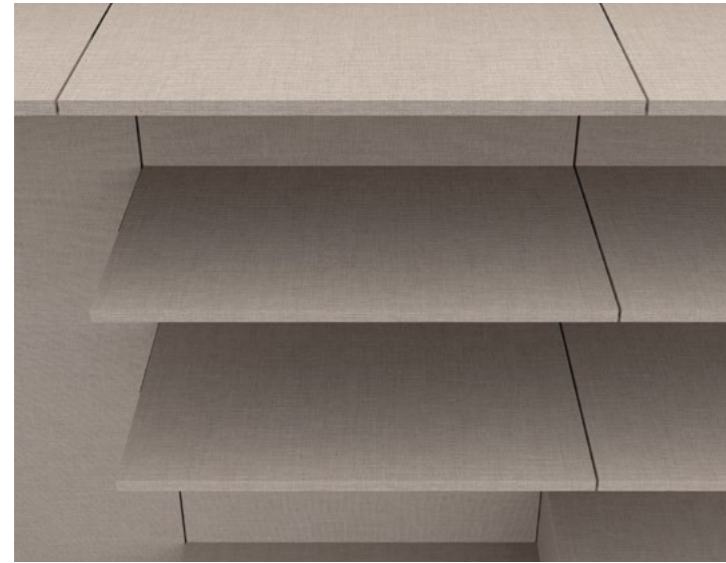

**Mensola**  
Shelf



**Telaio con sacca**  
Frame with bag

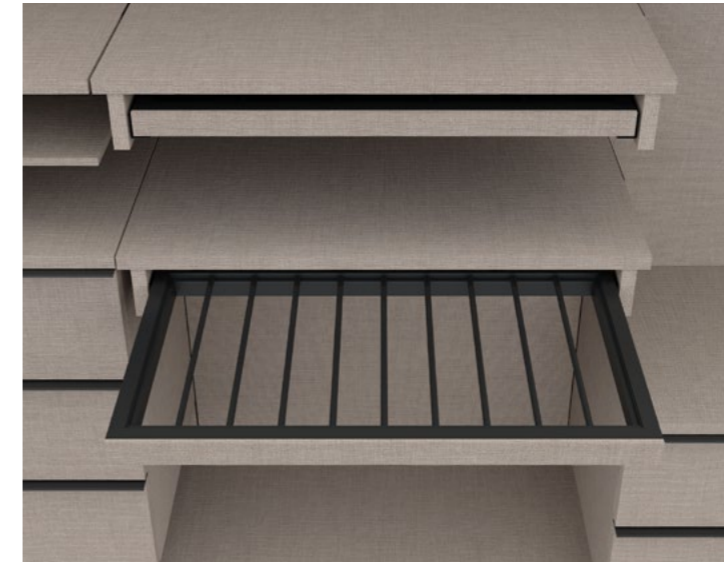

**Portapantaloni**  
Trousler rack



**Cassettiera**  
Chest of drawers

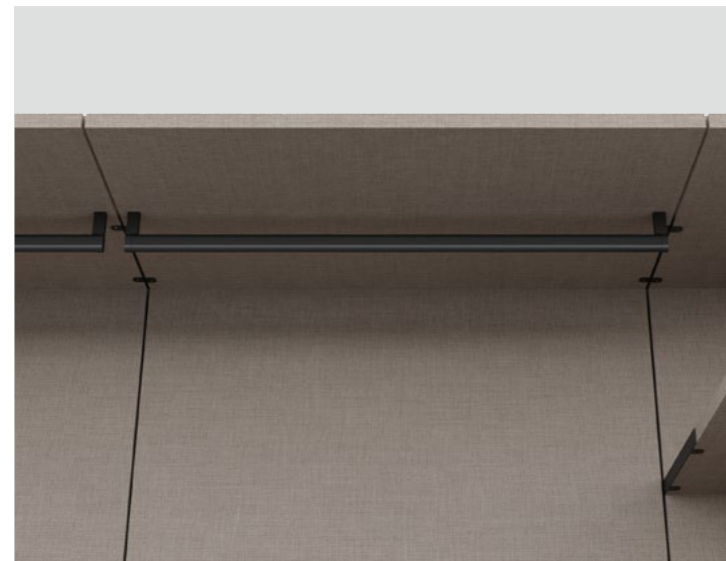

**Tubo appendiabiti**  
Clothes hanging rail



**Telaio con portacinture**  
Frame with belt holder



**Portascarpe**  
Shoe shelves

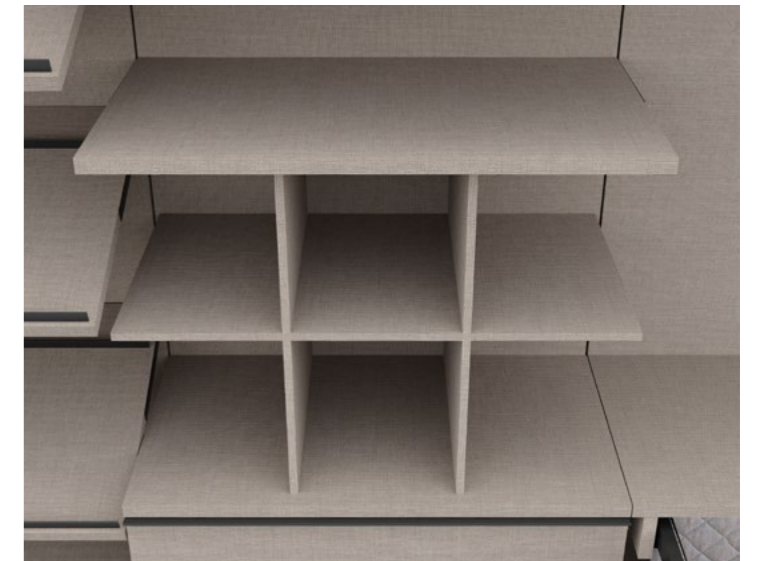

**Alveare**  
Pigeonhole

VERTICAL

## Dimensioni Dimensions

Il sistema per cabine armadio a montanti Vertical è disponibile in moduli da quattro larghezze e in quattro altezze diverse, per la massima adattabilità.

The Vertical upright walk-in wardrobe system is available in modules of four widths and in four different heights, for maximum adaptability.

### Altezze / Heights

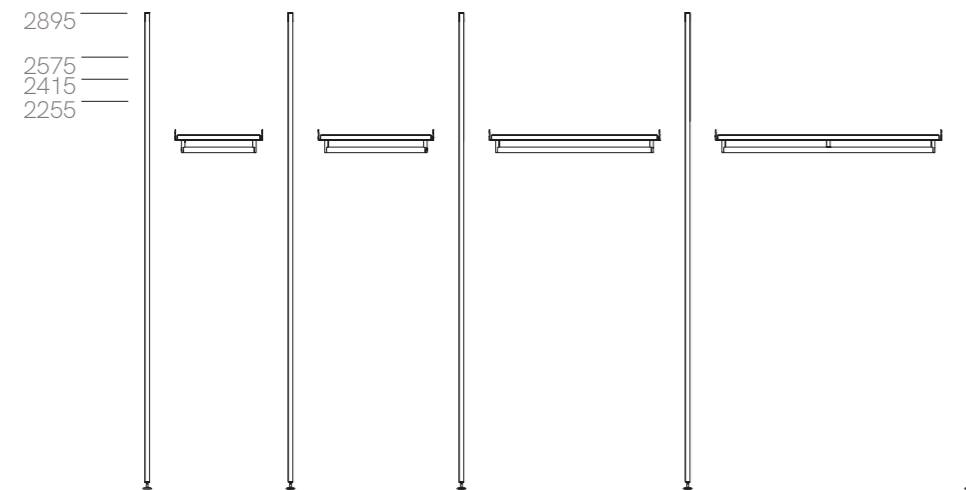

### Profondità / Depth

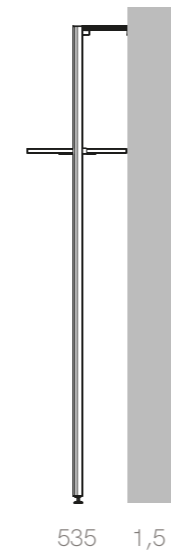

### Larghezze / Widths

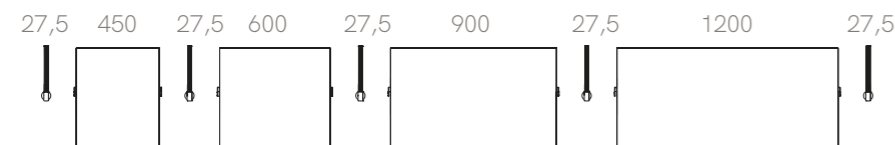

VERTICAL

## Componenti struttura Structure components

Gli elementi che compongono il sistema Vertical possono essere combinati per adattarsi a ogni esigenza. Oltre ai componenti strutturali sono disponibili mensole, portapantaloni, alveari, cassettiere, portascarpe e tubi appendiabiti.

The elements that make up the Vertical system can be combined to adapt to every need. In addition to the structural components, shelves, trouser racks, pigeonholes, chests of drawers, shoe shelves and clothes hanging rails are available.

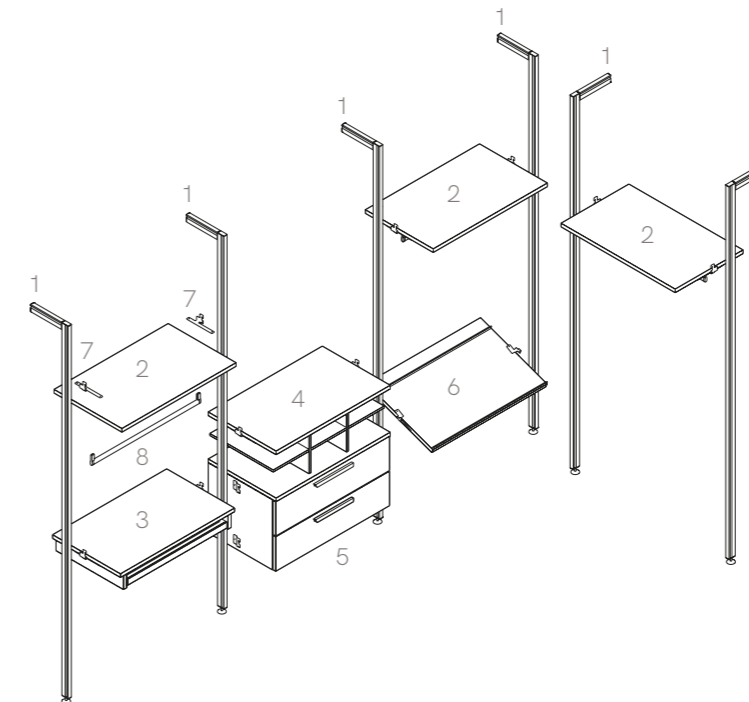

### Sistema a montanti: elementi strutturali

- 1 Montante di struttura
- 2 Mensola
- 3 Portapantaloni
- 4 Alveare
- 5 Cassettiera
- 6 Mensola Portascarpe
- 7 Reggimensola
- 8 Tubo Appendiabiti

### Upright system: structural elements

- 1 Structural upright
- 2 Shelf
- 3 Trouser track
- 4 Pigeonhole
- 5 Chest of drawers
- 6 Shoe shelves
- 7 Shelf bracket
- 8 Clothes hanging rail

VERTICAL

## Componenti struttura Structure components

### Tipologie pali

- 1 Montante a muro
- 2 Montante a soffitto

### Pole typologies

- 1 Wall upright
- 2 Ceiling upright

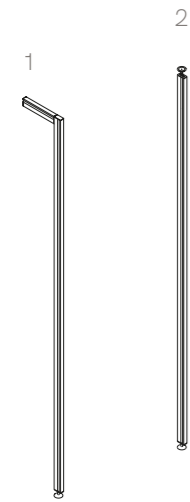

### Aggancio a muro Wall hook



### Aggancio a soffitto Ceiling hook



### Colori laccature Metal Metal lacquer colors

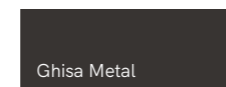

VERTICAL

## Componenti struttura Structure components

### Tipologie base e mensole

- 1 Mensola con reggimensola
- 2 Mensola portascarpe con reggimensola

### Base and shelves types

- 1 Shelf with shelf bracket
- 2 Shoe shelves with shelf bracket

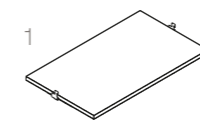

### Tipologie appendiabiti

- 1 Tubo appendiabiti

Clothes hanging rails type  
1 Clothes hanging rail



### Nobilitati Melamines

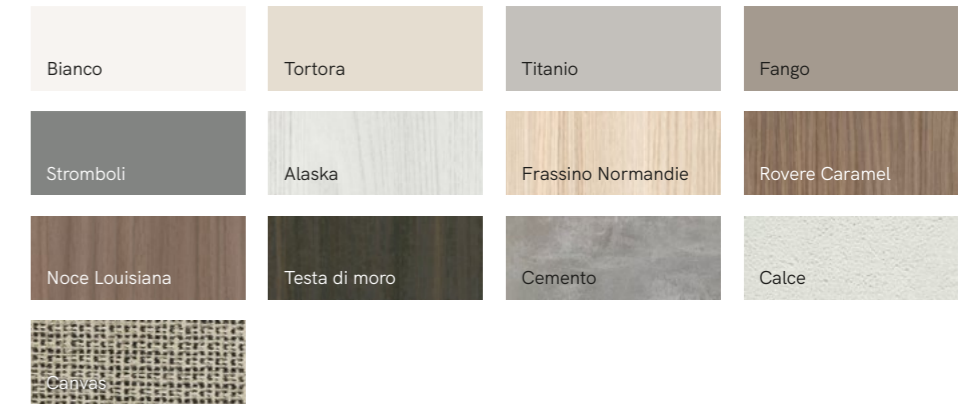

### Colori laccature Lacquer colors



### Colori laccature Metal Metal lacquer colors



### Colori laccature Metal Metal lacquer colors

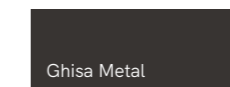

## VERTICAL

## Organizzazione degli interni

### Interior organization

**1**  
Mensole  
Alveare  
Cassettiera

1  
Shelves  
Pigeonhole  
Chest of drawers

**2**  
Mensola  
Mensole portascarpe

2  
Shelf  
Shoe shelves

**3**  
Mensole  
Alveare  
Cassettiera

3  
Shelves  
Pigeonhole  
Chest of drawers

**4**  
Mensola  
Tubo appendiabiti  
Telaio con sacca

4  
Shelf  
Clothes hanging rail  
Frame with bag

**5**  
Mensola  
Tubo appendiabiti  
Alveare  
Cassettiera

5  
Shelf  
Clothes hanging rail  
Pigeonhole  
Chest of drawers

**6**  
Mensola  
Tubo appendiabiti  
Telai portapantaloni

6  
Shelf  
Clothes hanging rail  
Trousers rack



1

2

3



4

5

6

VERTICAL  
Attrezzature  
Equipment



**Mensola**  
Shelf



**Telaio con sacca**  
Frame with bag



**Portapantaloni**  
Trousers rack



**Cassettiera**  
Chest of drawers



**Tubo appendiabiti**  
Clothes hanging rail



**Telaio con portacinture**  
Frame with belt holder



**Portascarpe**  
Shoe shelves



**Alveare**  
Pigeonhole

Informazioni tecniche  
Isola Domino  
Porte scorrevoli

**Technical information**  
**Domino Island**  
**Sliding doors**

## Isola Domino Domino Island

L'isola Domino è un elemento centrostanza composto da moduli a cassetiera, ad alveare o con vani a giorno verticali. Le composizioni possono essere monofacciali o bifacciali, con larghezza totale compresa tra 1200 e 2400 mm e corredate da un ripiano in vetro.

The Domino Island is a free-standing element made up of chest of drawers, pigeonholes or vertical open compartments. The compositions can be single- or double-sided, with a total width between 1200 and 2400 mm and accompanied by a glass shelf.



## Isola Domino / Componenti struttura Domino Island Structure components

### Composizione monofacciale One-sided composition

- 1 Ripiano in vetro
- 2 Top di finitura
- 3 Fianco
- 4 Schienale

- 1 Glass shelf
- 2 Finishing top
- 3 Side
- 4 Back

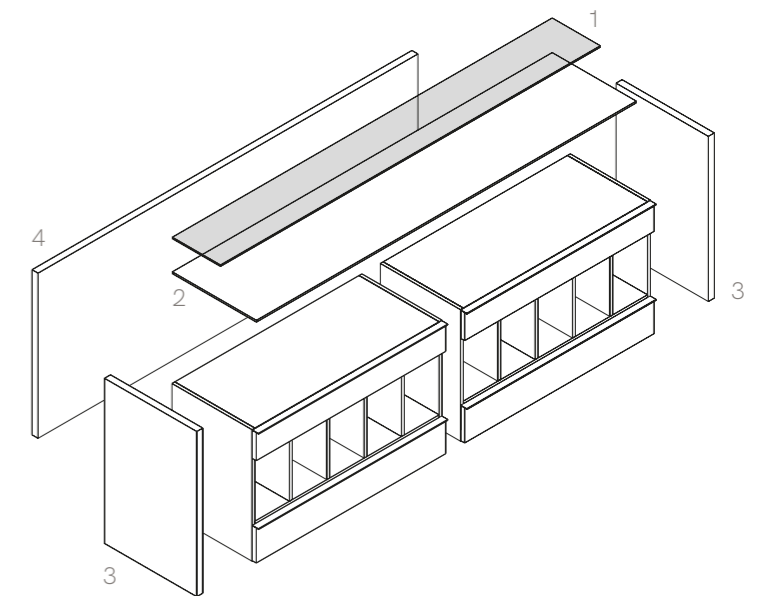

### Moduli e misure Modules and measures

- 1a Cassetiera da 1200 mm
- 1b Cassetiera da 900 mm
- 1c Cassetiera da 600 mm
- 2a Alveare da 1200 mm
- 2b Alveare da 900 mm
- 3a Vani a giorno da 1200 mm
- 3b Vani a giorno da 900 mm

- 1a 1200 mm chest of drawers
- 1b 900 mm chest of drawers
- 1c 600 mm chest of drawers
- 2a 1200 mm pigeonhole
- 2b 900 mm pigeonhole
- 3a 1200 mm open compartments
- 3b 900 mm open compartments

Profondità moduli: 545 mm  
Modules depth: 545 mm

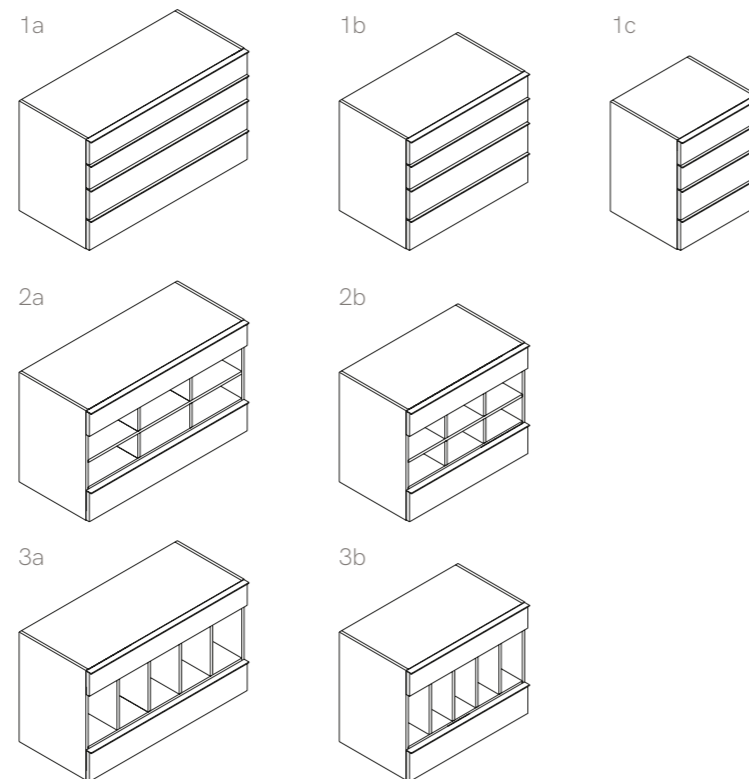

### Composizione bifacciale Double-sided composition

- 1 Ripiano in vetro
- 2 Top di finitura
- 3 Fianco
- 4 Schienale

- 1 Glass shelf
- 2 Finishing top
- 3 Side
- 4 Back

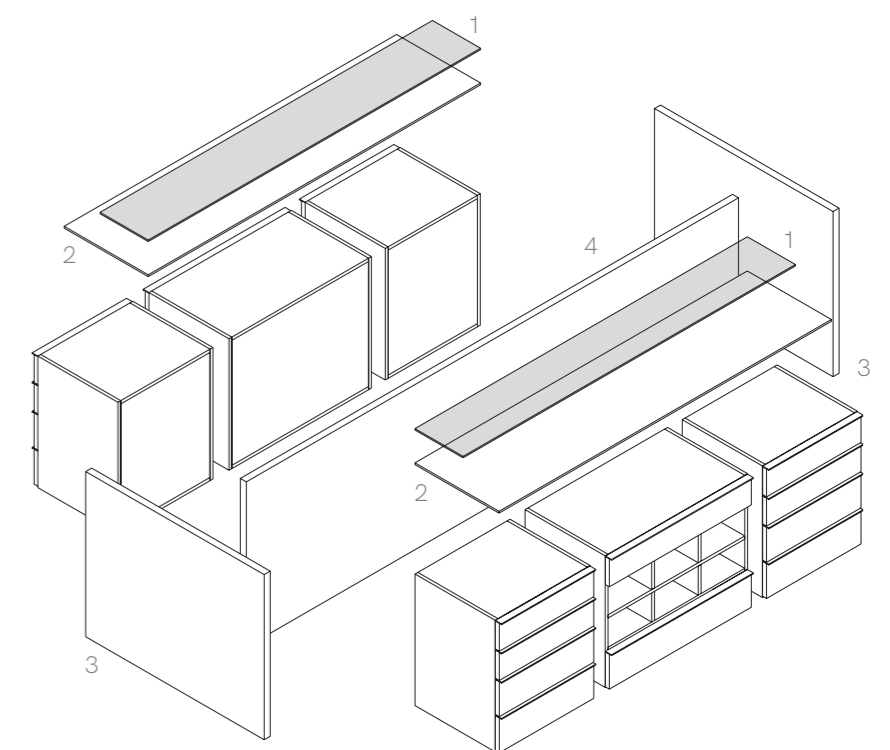

## Esempi di composizioni Examples of compositions

### Composizioni monofacciali profondità 583 mm Single-sided compositions depth 583 mm

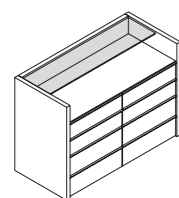

Composizione largh. 1200  
Composition width 1200

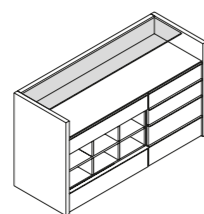

Composizione largh. 1500  
Composition width 1500

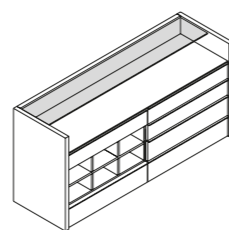

Composizione largh. 1800  
Composition width 1800

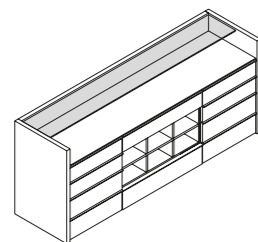

Composizione largh. 2100  
Composition width 2100

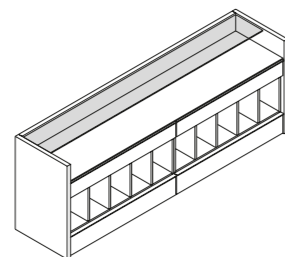

Composizione largh. 2400  
Composition width 2400

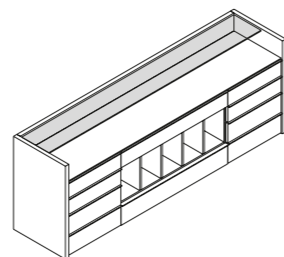

Composizione largh. 2400  
Composition width 2400

### Composizioni bifacciali profondità 1128 mm Double-sided compositions depth 1128 mm

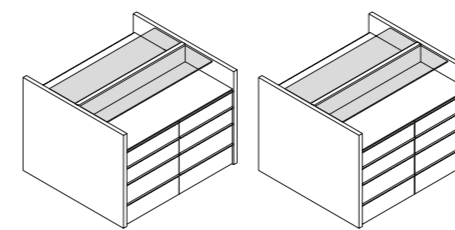

Composizione largh. 1200  
Composition width 1200

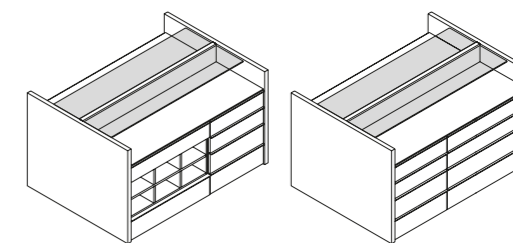

Composizione largh. 1500  
Composition width 1500

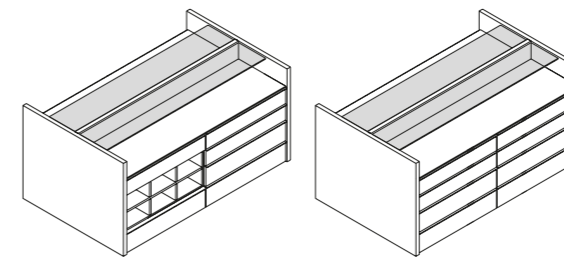

Composizione largh. 1800  
Composition width 1800

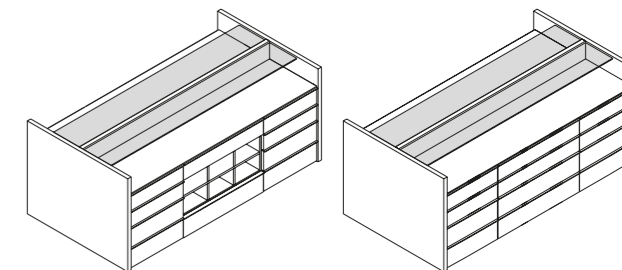

Composizione largh. 2100  
Composition width 2100

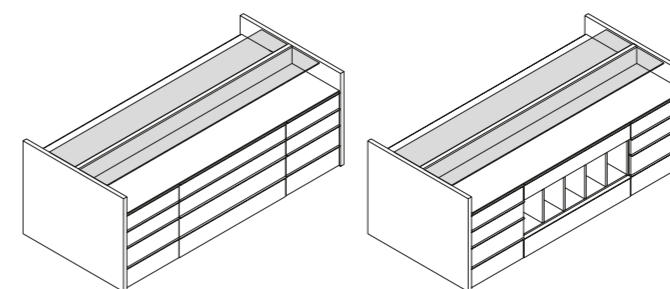

Composizione largh. 2400  
Composition width 2400

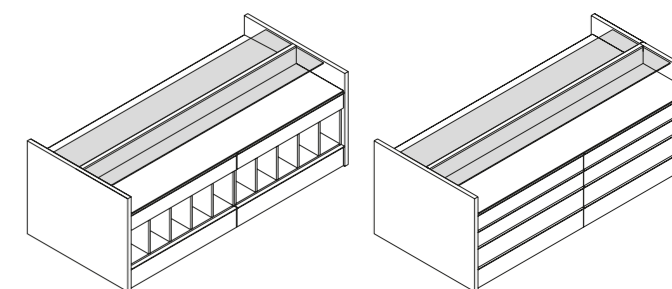

Composizione largh. 2400  
Composition width 2400

## Porta Dea

Dea è la porta scorrevole in vetro o pannello che può essere utilizzata per la chiusura di cabine armadio oppure come divisorio tra diversi ambienti.

Dea is the glass or panel sliding door that can be used to close walk-in wardrobes or as a divider between different environments.

### Versioni / Versions

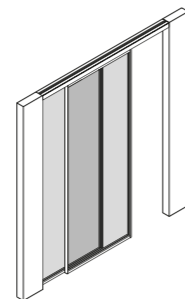

### Dimensioni porta Scorrevole

completamente a misura  
h max 3000  
l max singola anta 1485

Sliding door dimensions  
completely tailored  
h max 3000  
w max single door 1485

### Maniglia e profili

- profilo estruso in alluminio
- disponibile nel colore Ghisa Metal e Bianco
- maniglia con presa facilitata
- nessun segno di fissaggio o vite a vista

### Handle and profiles

- extruded aluminum profile
- available in Ghisa Metal and Bianco
- handle with easy grip
- no signs of fixing or visible screws



### Vetro

Glass

Trasparente\*

Transparent

Fumé

Smoked

Bronzo

Bronze

### Vetro acidato

Etched glass

Trasparente

Fumé

Smoked

Bronzo

Bronze

### Specchio

Mirror

Argentato

Silver

Fumé

Smoked

Bronzo

Bronze

### Colori laccature vetro lucido

Lacquered colors for profile

Bianco

Ghiaccio

Titanio

Cenere

Selva

Stromboli

Tortora

Canapa

Argilla

Fango

Brandy

Fondente

Salvia

Edera

Tirreno

Baltico

Ametista

Granata

### Colori laccature Metal per profilo

Metal lacquered colors for profile

Ghisa Metal

Bianco

\* Disponibile anche laccato nelle finiture riportate a lato, esclusi i colori laccature Metal  
Available lacquered in the finishes shown on the side, excluding Metal lacquer colors

## Porta Ghost

Ghost è la porta scorrevole a scomparsa in vetro, che può essere utilizzata per la chiusura di cabine armadio oppure come divisorio tra diversi ambienti.

Ghost is the glass disappearing sliding door, which can be used to close walk-in wardrobes or as a divider between different environments.

### Versioni / Versions

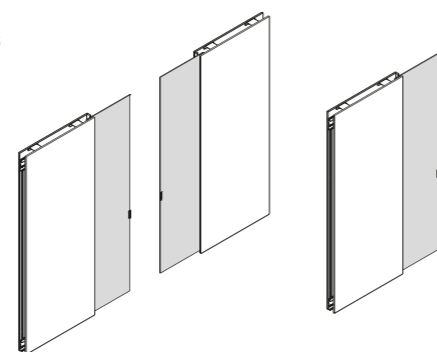

Due ante  
Two doors

Anta singola  
Single door

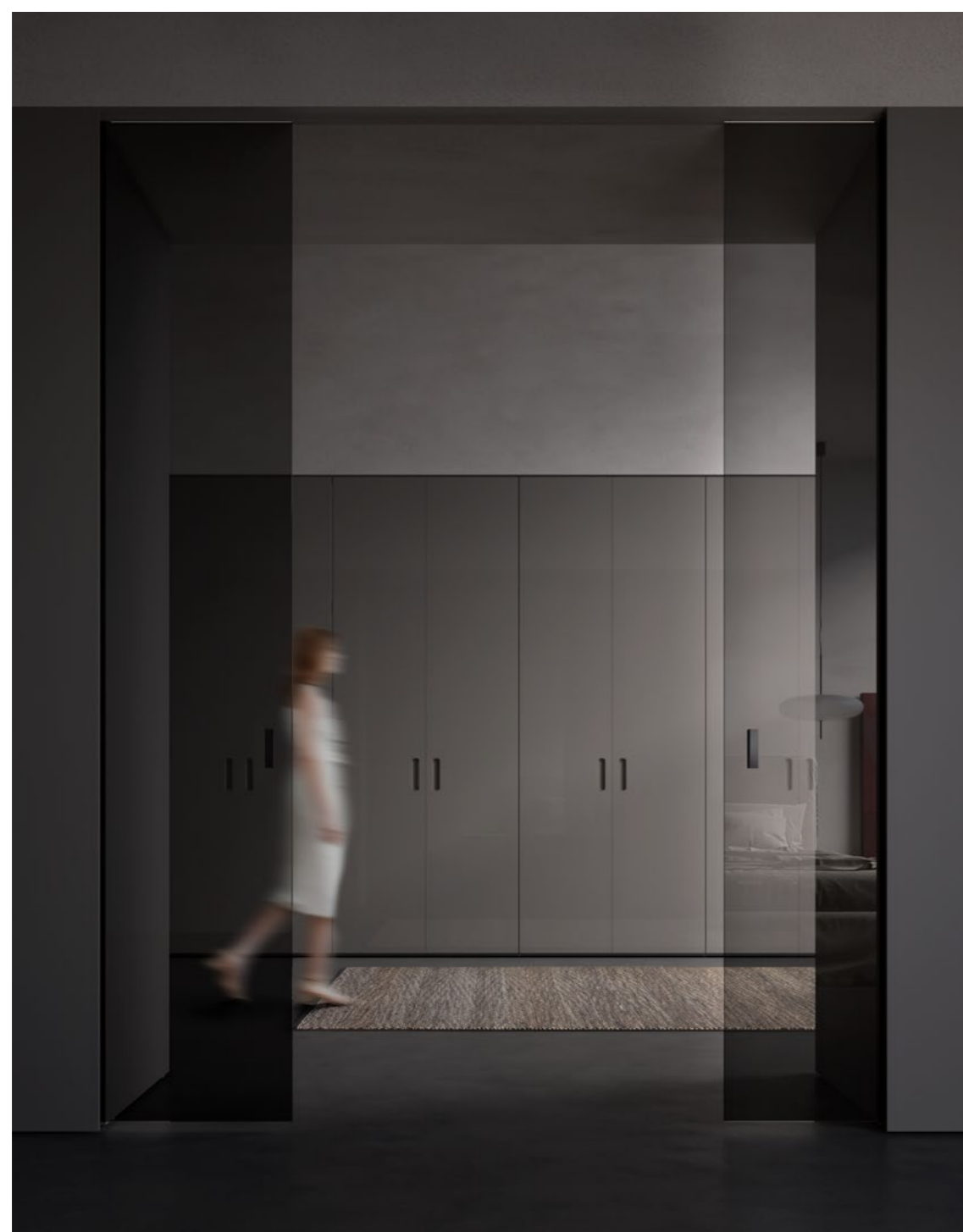

### Dimensioni porta Scorrevole

completamente a misura  
h max 3000  
l max singola anta 1000

Sliding door dimensions  
completely tailored  
h max 3000  
w max single door 1000

### Maniglia

- profilo estruso in alluminio
- disponibile nel colore Ghisa Metal
- maniglia con presa facilitata
- nessun segno di fissaggio o vite a vista

### Handle

- extruded aluminum profile
- available in Ghisa Metal
- handle with easy grip
- no signs of fixing or visible screws

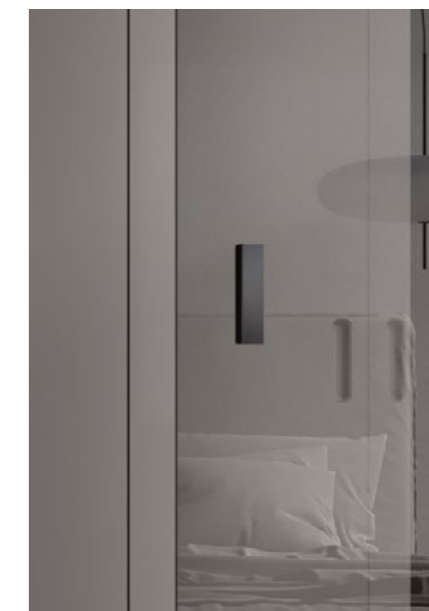

### Vetro

Glass

Trasparente  
Transparent

Fumé  
Smoked

Bronzo  
Bronze

### Vetro acidato

Etched glass

Trasparente  
Transparent

Fumé  
Smoked

Bronzo  
Bronze

### Colori laccature Metal per maniglia

Metal lacquer colors for the handle

Ghisa Metal

Indice delle composizioni  
**Composition Index**

Armadi anta battente / Hinged door wardrobes

Armadi anta battente / Leaf door wardrobes



COMP. 01 > PAG 6 Anta Crystal Anta Low



COMP. 02 > PAG 18 Anta Ruler Anta Crystal



COMP. 09 > PAG 76 Anta Row



COMP. 10 > PAG 88 Anta Joint



COMP. 03 > PAG 28 Anta Line + Maniglia Slot Anta Crystal



COMP. 04 > PAG 36 Anta Soft



COMP. 11 > PAG 96 Anta Line + Maniglia Ego



COMP. 12 > PAG 102 Anta Return



COMP. 05 > PAG 46 Anta Double



COMP. 06 > PAG 54 Anta Double



COMP. 13 > PAG 110 Anta Line + Maniglia Slot



COMP. 14 > PAG 118 Anta Line + Maniglia Trapezio



COMP. 07 > PAG 60 Anta Fit



COMP. 08 > PAG 68 Anta Line + Maniglia Duo



COMP. 15 > PAG 130 Anta Return

Armadi ante scorrevoli / Sliding door wardrobes

Cabine armadio / Walk-in closets



COMP. 01 > PAG 142 Anta Ritmo



COMP. 02 > PAG 150 Anta Mondrian



COMP. 03 > PAG 158 Anta Plane



COMP. 04 > PAG 164 Anta Shine

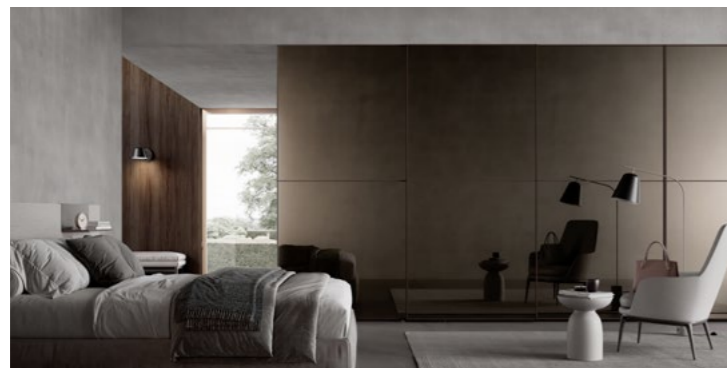

COMP. 05 > PAG 170 Anta Square



COMP. 01 > PAG 180 Cabina 1  
Walk-in wardrobe 1



COMP. 01B > PAG 188 Variante cabina 1  
Walk-in wardrobe variant 1

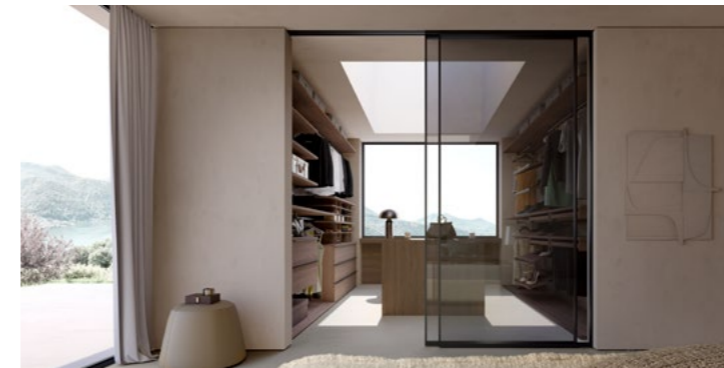

COMP. 02 > PAG 194 Cabina 2  
Walk-in wardrobe 2



COMP. 3 > PAG 206 Cabina 3  
Walk-in wardrobe 3



COMP. 04 > PAG 210 Cabina 4  
Walk-in wardrobe 4

# La Sostenibilità è più di un solo obiettivo

Sustainability is more than just a goal

**La mission sostenibile di Adok adotta un approccio “design oriented”:** termine che indica una naturale e tradizionale attitudine alla progettualità, all'estetica e all'uso creativo oltre che razionale e responsabile delle risorse.

In ogni nostro progetto poniamo in relazione le caratteristiche sensibili del prodotto con le impressioni, le esperienze e le emozioni che può suscitare, per agevolare un legame durevole con chi lo utilizzerà: pensando che è bello, sostenibile, non solo utile. L'idea di design sostenibile perseguita da Adok va oltre quella del puro design di prodotto, e punta a un nuovo design del prodotto/servizio, capace di corrispondere anche ai desideri dell'utente, della società e del “sistema-azienda”.

**Adok's sustainable mission adopts a “design oriented” approach:** a term that indicates a natural and traditional aptitude for planning, aesthetics and creative use as well as rational and responsible use of resources. In each of our projects we relate the sensitive characteristics of the product with the impressions, experiences and emotions it can arouse, to facilitate a lasting connection with those who will use it: thinking that it is beautiful, sustainable, not just useful. The idea of sustainable design pursued by Adok goes beyond that of pure product design, and aims at a new product/service design, capable of responding to the wishes of the user, society and the “company-system”.

Un modello di Sostenibilità che trova fondamento in 5 principi cardine:  
A model of Sustainability based on 5 key principles:



#### Ricerca

Essere artefici della Sostenibilità significa sviluppare una ricerca consapevole e responsabile, orientandone gli scopi verso l'adozione di materiali sostenibili e di qualità progettuali.

#### Research

Being creators of Sustainability means developing conscious and responsible research, directing its purposes towards the adoption of sustainable materials and design quality.



#### Accoglienza

Progettare spazi accoglienti e realizzare prodotti che trasmettano armonia e comfort, in quanto espressione di scelte responsabili allo stesso tempo verso l'uomo e l'ambiente.

#### Hospitality

Design welcoming spaces and create products that convey harmony and comfort, as an expression of responsible choices towards both the humankind and the environment.



#### Trasformabilità

Sviluppare ambienti flessibili e prodotti modulari, che si possano adattare facilmente alle esigenze degli utenti, in simbiosi con bisogni e desideri in trasformazione.

#### Transformability

Develop flexible environments and modular products, which can be easily adapted to user needs, in symbiosis with changing needs and desires.



#### Salute

Impiegare materiali e sostanze naturali e sicuri per la salute umana e per l'ambiente, con cicli produttivi a basso impatto ambientale e sicuri per i lavoratori.

#### Health

Using natural materials and substances that are safe for human health and the environment, with production cycles with low environmental impact and safe for workers.



#### Cultura

Agire sulla cultura d'impresa e dei consumatori per guidare il comportamento sociale verso un uso più sostenibile dei prodotti e dei servizi.

#### Culture

Act on corporate and consumer culture to guide social behavior towards a more sustainable use of products and services.



# Progettare con la natura

## Designing with nature

**Adok progetta e produce facendo riferimento alle espressioni della natura e traendo ispirazione dai suoi materiali primari e dalla rinnovabilità.**

Adok designs and manufactures by referencing the expressions of nature and drawing inspiration from its primary materials and renewability.

Tutti gli arredi Adok sono realizzati impiegando pannelli in **legno** truciolare melaminico nobilitato, i cui costituenti legnosi derivano da foreste gestite in maniera responsabile e da legno riciclato. Una scelta responsabile che contribuisce non solo alla tutela dell'ambiente, ma anche al conseguimento di benefici sociali e di sostenibilità economica.

Una tutela rivolta parimenti ai consumatori: infatti, il materiale legnoso truciolare, impiegato da Doimo Cityline, risulta certificato dai produttori per la bassissima emissione di formaldeide (un composto organico volatile dannoso per la salute umana) in accordo sia alle disposizioni di legge italiane e comunitarie, che ai regolamenti statunitensi CARB ATCM Phase II /U.S. EPA TSCA Title VI.

Giunti a fine vita gli arredi Adok possono essere avviati totalmente al riciclo dei materiali costituenti. In primis le parti legnose possono essere recuperate per essere trasformate in nuova materia prima destinata a realizzare prodotti sostenibili e funzionali.

All Adok furnishings are made using melamine faced chipboard panels, whose **wood** constituents derive from responsibly managed forests and recycled wood.

A responsible choice that contributes not only to environmental protection, but also to the achievement of social benefits and economic sustainability.

A protection equally aimed at consumers: in fact, the chipboard wood material used by Doimo Cityline is certified by the producers for the very low emission of formaldehyde (a volatile organic compound harmful to human health) in accordance with both the Italian and EU legal provisions, which to the US regulations CARB ATMM Phase II /U.S. EPA TSCA Title VI. Once they have reached the end of their life, Adok furnishings can be totally recycled of the constituent materials.

First of all, the woody parts can be recovered to be transformed into new raw material destined to create sustainable and functional products.

Attraverso opportuni trattamenti, gli **scarti di produzione** derivanti dalla lavorazione del legno e dei relativi semilavorati sono oggi interamente reimmessi nel sistema: in parte destinati alla produzione di nuova materia prima, in parte come fonte per produrre energia termica.

Through appropriate treatments, the **production waste** deriving from the processing of wood and the related semi-finished products are today entirely reintroduced into the system: partly destined for the production of new raw material, partly as a source for producing thermal energy.

Oltre al legno, le parti accessorie, come maniglie e i piedini, dei mobili Adok sono anche realizzate in **alluminio** o **zama**, materiali anch'essi derivanti da processi di riciclo. Grazie alle loro proprietà, anche le leghe di alluminio e zama concorrono a conferire l'elevata circolarità dei prodotti Adok, infatti se conferite correttamente, possono essere riciclate infinite volte senza perdere nessuna delle sue proprietà fisiche e meccaniche. L'impiego di questi materiali metallici (o del legno) ha consentito anche ad Adok di ridurre sensibilmente l'utilizzo di quelli plastici. Ove non è stato possibile operare la sostituzione, per esempio per realizzare certe tipologie di bordi, viene oggi impiegato materiale plastico di elevata qualità (ABS atossico) e completamente riciclabile a fine vita.

In addition to wood, the accessory parts, such as handles and feet, of Adok furniture are also made of **aluminum** or **zamak**, materials also deriving from recycled processes. Thanks to their properties, aluminum and zamak alloys also contribute to giving the high circularity of Adok products, in fact if handled correctly, they can be recycled countless times without losing any of their physical and mechanical properties. The use of these metal materials (or wood) has also allowed Adok to significantly reduce the use of plastic ones. Where it has not been possible to operate the replacement, for example to create certain types of edges, high quality plastic material (non-toxic ABS) and completely recyclable at the end of its life is now used.

Il **vetro** è adottato in maniera consapevole nei processi produttivi Adok, sfruttandone tutte le caratteristiche sostenibili ed estetiche. Materiale sinonimo di trasparenza e leggerezza, può essere riciclato e riciclabile al 100% e quindi reintrodotta infinite volte nel ciclo produttivo.

**Glass** is consciously adopted in the Adok production processes, exploiting all its sustainable and aesthetic characteristics. Material synonymous with transparency and lightness, it can be 100% recycled and recyclable and therefore reintroduced countless times into the production cycle.

La totale sostituzione delle **vernici** a solvente organico con quelle a base acqua, certificate dai produttori in Classe A+ (indica il più basso livello previsto di emissioni indoor di sostanze dannose, per la salute umana e l'ambiente), nella realizzazione di Adok garantisce elevati standard di salubrità dell'aria e basso impatto ambientale.

The total replacement of organic solvent **paints** with water-based ones, certified by the manufacturers in Class A+ (indicates the lowest expected level of indoor emissions of substances harmful to human health and the environment), in the creation of Adok guarantees high air health standards and low environmental impact.

Tutti gli **apparecchi elettrici ed elettronici** adottati negli arredi Adok, come per esempio lampade e alimentatori, sono certificati RoHS: direttiva europea che impone forti restrizioni alla presenza di sostanze pericolose per l'ambiente e la salute umana e che definisce i stringenti criteri per il recupero e lo smaltimento a fine vita dei dispositivi elettrici ed elettronici.

All **electrical and electronic appliances** used in Adok furnishings, such as lamps and ballasts, are RoHS certified: a European directive which imposes strong restrictions on the presence of substances dangerous for the environment and human health and which defines stringent recovery criteria and end-of-life disposal of electrical and electronic devices.

Anche l'accurata progettazione degli **imballi** di Adok permette di ridurre il quantitativo di rifiuti prodotti e di energia impiegata, e implementa il riciclo e la differenziazione dei materiali.

Even the careful design of Adok's **packaging** makes it possible to reduce the amount of waste produced and energy used, by implementing the recycling and differentiation of materials.

Carta e digitale, ovvero "materia e bit", costituiscono strumenti alternativi che occorre calibrare per una corretta gestione sostenibile delle risorse. Tra le prime aziende del settore arredo Doimo Cityline ha introdotto la **digitalizzazione** di tutti i documenti di vendita e di trasporto destinati ai clienti, di cui Adok ne è parte integrante e rappresentativa di questo processo virtuoso di dematerializzazione. Altresì l'azienda ha adottato una politica di gestione paperless dei documenti e dei processi che contribuisce in maniera rilevante a preservare, eliminando l'impiego massivo di carta, il patrimonio boschivo e a ridurre le emissioni di gas climalteranti.

Paper and digital, or "matter and bits", are alternative tools that need to be calibrated for correct sustainable management of resources. Among the first companies in the furniture sector, Doimo Cityline has introduced the **digitization** of all sales and transport documents intended for customers, of which Adok is an integral and representative part of this virtuous process of dematerialization. The company has also adopted a policy of paperless management of documents and processes which contributes significantly to preserving, by eliminating the massive use of paper, the forest heritage and to reducing climate-altering gas emissions.

L'attività produttiva di Adok si svolge con un'attenta gestione dei **consumi energetici**. Periodicamente il sistema di produzione è sottoposto a diagnosi energetiche finalizzate a migliorarne ulteriormente l'efficienza e le prestazioni. Una particolare attenzione è riservata all'ottimizzazione nell'impiego di energia elettrica per le utilities ad asservimento dei processi produttivi e alla

pianificazione di interventi sull'impianto di illuminazione, con l'introduzione di fonti led a basso consumo e di sistemi di accensione con rilevatori di presenza.

Adok's production activity takes place with careful management of **energy consumption**. Periodically, the production system is subjected to energy audits aimed at further improving its efficiency and performance. Particular attention is paid to optimizing the use of electricity for utilities serving production processes and planning interventions on the lighting system, with the introduction of low-consumption LED sources and ignition systems with detectors of presence.

I **processi produttivi** Adok sono basati su piattaforme digitali e impianti automatizzati di ultima generazione per il controllo della qualità e la gestione delle risorse. Appositi sistemi software sono dedicati a ottimizzare i piani di taglio e la precisione delle lavorazioni, coniugando l'affidabilità e la facilità di precisi montaggi dei mobili con il massimo contenimento degli scarti di lavorazione. Il controllo attento del prodotto, della snellezza dei processi produttivi e dell'ottimizzazione dei parametri permettono al sistema di garantirne qualità, affidabilità e sicurezza.

Adok **production processes** are based on digital platforms and latest generation automated systems for quality control and resource management. Specific software systems are dedicated to optimizing the cutting planes and machining precision, combining the reliability and ease of precise furniture assembly with maximum containment of manufacturing waste. The careful control of the product, the streamlining of the production processes and the optimization of the parameters allow the system to guarantee its quality, reliability and safety.

Adok nasce ed è espressione di una sostenibilità improntata anche al rispetto dei **diritti dei lavoratori** e allo sviluppo di misure di welfare sociale che ne migliorino il benessere e l'equilibrio tra crescita professionale e vita privata. Le politiche aziendali che adotta Doimo Cityline sono

promotrici di uguaglianza, tutela delle vulnerabilità, inclusione sociale, salute e sicurezza. L'adozione dei Sistemi di Gestione per la Qualità, l'Ambiente e la Sicurezza (declinati nelle certificazioni UNI EN ISO 9001, UNI EN ISO 14001 e UNI ISO 45001) e unitamente al modello organizzativo MOG 231 (D.Lgs. 231 volto a disciplinare le responsabilità amministrative delle Società), che stabilisce un codice etico, permettono all'azienda di gestire i propri processi tramite un sistema di Governance Integrata ed eticamente sostenibile, indirizzato alla creazione di valore e alla garanzia della sostenibilità del business in una prospettiva di lungo periodo.

Adok was born and is the expression of a sustainability also based on respect for **workers' rights** and the development of social welfare measures that improve their well-being and the balance between professional growth and private life. The company policies adopted by Doimo Cityline are promoters of equality, protection of vulnerabilities, social inclusion, health and safety. The adoption of the Quality, Environment and Safety Management Systems (declined in the UNI EN ISO 9001, UNI EN ISO 14001 and UNI ISO 45001 certifications) and together with the MOG 231 organizational model (Legislative Decree 231 aimed at regulate the administrative responsibilities of the Companies), which establishes a code of ethics, allow the company to manage its processes through an Integrated and ethically sustainable Governance system, aimed at creating value and guaranteeing the sustainability of the business in a long-term perspective period.



AD  
**sciutoarchitetti**

Graphic Design  
romanoassociati.com

Digital Images  
**Gabriotti Fotografi**

styling  
**Gabriotti Fotografi**

press / pre-press  
**Grafiche Antiga**

printed in Italy  
**marzo 2023**

I colori riprodotti sono indicativi  
e possono differire leggermente  
da quelli reali.

The colours reproduced are  
indicative and may slightly differ  
from the original ones.

**ADOK è un marchio**  
**Doimo Cityline Srl**

Viale Europa Unita, 12  
31010 Moriago della Battaglia TV  
Tel. +39 0438 8918  
Fax +39 0438 892922  
info@adok.it  
www.adok.it